



FINAL REPORT

ER-1422: Biodegradation of 1,4-Dioxane

**Robert J. Steffan
Shaw Environmental, Inc.**

August 2007

This report was prepared under contract to the Department of Defense Strategic Environmental Research and Development Program (SERDP). The publication of this report does not indicate endorsement by the Department of Defense, nor should the contents be construed as reflecting the official policy or position of the Department of Defense. Reference herein to any specific commercial product, process, or service by trade name, trademark, manufacturer, or otherwise, does not necessarily constitute or imply its endorsement, recommendation, or favoring by the Department of Defense.

REPORT DOCUMENTATION PAGE

*Form Approved
OMB No. 0704-0188*

The public reporting burden for this collection of information is estimated to average 1 hour per response, including the time for reviewing instructions, searching existing data sources, gathering and maintaining the data needed, and completing and reviewing the collection of information. Send comments regarding this burden estimate or any other aspect of this collection of information, including suggestions for reducing the burden, to the Department of Defense, Executive Services and Communications Directorate (0704-0188). Respondents should be aware that notwithstanding any other provision of law, no person shall be subject to any penalty for failing to comply with a collection of information if it does not display a currently valid OMB control number.

PLEASE DO NOT RETURN YOUR FORM TO THE ABOVE ORGANIZATION.

1. REPORT DATE (DD-MM-YYYY) 01/08/2007		2. REPORT TYPE Draft Final Report		3. DATES COVERED (From - To) 27/01/2005 - 01/08/2007	
4. TITLE AND SUBTITLE Biodegradation of 1,4-Dioxane				5a. CONTRACT NUMBER W912HQ-04-C-0041	
				5b. GRANT NUMBER CU-1422	
				5c. PROGRAM ELEMENT NUMBER	
6. AUTHOR(S) Steffan, Robert J., McClay, Kevin R, Masuda, Hisako and Zylstra, Gerben J.				5d. PROJECT NUMBER	
				5e. TASK NUMBER	
				5f. WORK UNIT NUMBER	
7. PERFORMING ORGANIZATION NAME(S) AND ADDRESS(ES) Shaw Environmental, Inc. 17 Princess Rd. Lawrenceville, New Jersey 08648 Rutgers University, Cook College, Foran Hall, New Brunswick, New Jersey 08903				8. PERFORMING ORGANIZATION REPORT NUMBER	
9. SPONSORING/MONITORING AGENCY NAME(S) AND ADDRESS(ES) Strategic Environmental Research and Development Program SERDP Program Office 901 North Stuart Street, Suite 303 Arlington, VA 22203				10. SPONSOR/MONITOR'S ACRONYM(S) SERDP	
				11. SPONSOR/MONITOR'S REPORT NUMBER(S)	
12. DISTRIBUTION/AVAILABILITY STATEMENT Approved for public release, distribution unlimited					
13. SUPPLEMENTARY NOTES					
14. ABSTRACT The specific goals of this project were: 1) to evaluate biodegradation of 1,4-dioxane in environmental samples under different redox and chemical/physical conditions and different treatment regimes; 2) identify and isolate new 1,4-dioxane degrading microbes from environmental microcosms; 3) identify the products of 1,4-dioxane biodegradation by studying degradation pathways in pure bacterial cultures; 4) confirm that the same biodegradation pathways occur in active environmental samples; and 5) identify and evaluate genes involved in 1,4-dioxane biodegradation. Biodegradation of 1,4-dioxane in environmental samples was performed by utilizing microcosms constructed with samples from two hydrogeochemically different 1,4-dioxane-contaminated aquifers. The 1,4-dioxane biodegradation pathways were determined by elucidating 1,4-dioxane degradation products produced by bacterial strains ENV425, ENV473, and ENV478.					
15. SUBJECT TERMS					
16. SECURITY CLASSIFICATION OF:			17. LIMITATION OF ABSTRACT	18. NUMBER OF PAGES	19a. NAME OF RESPONSIBLE PERSON
a. REPORT	b. ABSTRACT	c. THIS PAGE			Robert J. Steffan, Ph.D.
UU	UU	UU	UU	115	19b. TELEPHONE NUMBER (Include area code)

Biodegradation of 1,4-Dioxane

**SERDP PROJECT CU-1422
FINAL REPORT**

Submitted by: Robert J. Steffan, Ph.D.
Shaw Environmental, Inc.
August 1, 2007

EXECUTIVE SUMMARY

Introduction. 1,4-dioxane has been used extensively as a stabilizing agent in chlorinated solvents such as 1,1,1-TCA, and it has recently emerged as an important groundwater contaminant throughout the United States and elsewhere. Because of its miscibility in water, its low Henry's Law constant (4.9×10^{-6} atm m³/mol), and low octanol/water partitioning coefficient (K_{oc} 1.23), it is poorly retarded in aquifers. As a result, this compound has the potential to create large contaminant plumes and to threaten drinking water supplies distant from the original release sites (Jackson and Dwarakanath, 1999; Priddle and Jackson, 1991). It has only recently been added to the list of pollutants that must be regularly monitored in several states. Advisory action levels for 1,4 dioxane have been set at very low levels in many states, including, California, 3 ppb; Florida, 5 ppb; Maine, 70 ppb; Massachusetts, 50 ppb; Michigan, 1 ppb; and North Carolina, 7 ppb. Similarly, the EPA has issued a health-based advisory level of 3 parts per billion (ppb) for drinking water.

Because chlorinated solvents have been widely used as cleaning solvents within the DOD and DOE, many DOD and DOE sites that have chlorinated solvent contamination also likely are contaminated with 1,4-dioxane. The possibility that the widespread occurrence of 1,4-dioxane in groundwater could result in the re-evaluation and re-opening of chlorinated solvent sites within the DOD and DOE complexes has highlighted the need to evaluate the fate of this compound in the environment and to identify new and effective treatment approaches (Mohr, 2001). The California Regional Water Quality Control Board (2003) requested that the DoD assist in identifying 1,4-dioxane sources at military bases in the State, and identified the following list of sites for evaluation.

Potential Source Areas for Emergent Chemicals Associated with Solvent Release Sites

- Catch basins, waste sumps, clarifiers, and settling ponds,
- Paint maintenance, hobby shops, plating shops, and degreasing activities,
- Weapons maintenance or cleaning areas, known release sites, as appropriate, and
- Suspected areas where these chemicals were stored, used, transferred, processed, incinerated, or disposed.

Few treatment methods have proven successful and economically feasible for removing 1,4-dioxane from groundwater. Because of its low K_{oc} and Henry's Law constant traditional remediation technologies like carbon adsorption and air stripping are inefficient and costly (Bowman et al., 2001). Likewise, *in situ* and *ex situ* biological treatments of 1,4-dioxane have not yet emerged as viable treatment options even though some microbes have been shown to degrade the compound. Only a few *ex situ* technologies including chemical oxidation with combined addition of ozone and hydrogen peroxide (Adams, et al., 1994; Bowman et al., 2001) or hydrogen peroxide and UV light (Stefan and Bolton, 1998) have been utilized commercially to destroy 1,4-

dioxane, but the cost of applying these technologies to high concentration waste streams can be prohibitive

Relatively few studies have evaluated biological degradation of 1,4-dioxane, but indigenous microorganisms typically are not able to degrade this compound (Fincher and Payne, 1962 and Francis et al., 1980). In the last several years, however, 1,4-dioxane biodegradation has been reported in both pure (Parales et al. 1994; Burbach and Perry 1993; Bernhardt and Diekmann 1991) and mixed cultures (Zenker et al., 2000). For example, a pure culture of *Mycobacterium vaccae* JOB5 was shown to partially degrade 1,4-dioxane, but not to grow on the compound (Burbach and Perry 1993). Likewise, Bernhardt and Diekmann (1991) reported the biodegradation of 1,4-dioxane as the sole carbon and energy source by a *Rhodococcus* strain, and Parales et al. (1994) isolated the only bacterium (strain CB1190) to date that is capable of sustained growth and mineralization of 1,4-dioxane, albeit at low rates. In other studies, mixed cultures of bacteria were able to degrade 1,4-dioxane, but only in the presence of the co-substrate tetrahydrofuran (THF) (Cowan et al., 1994; Zenker et al., 2000). Little or no controlled research has been done to evaluate 1,4-dioxane degradation under redox conditions that are common in aquifers (e.g., iron reducing, sulfate reducing, and methanogenic), or to evaluate the effect of co-contaminants or biostimulation additives (e.g., lactate; molasses, vegetable oils) on 1,4-dioxane degradation.

Project goals. The specific goals of this project were: 1) to evaluate biodegradation of 1,4-dioxane in environmental samples under different redox and chemical/physical conditions and different treatment regimes; 2) identify and isolate new 1,4-dioxane degrading microbes from environmental microcosms; 3) identify the products of 1,4-dioxane biodegradation by studying degradation pathways in pure bacterial cultures; 4) confirm that the same biodegradation pathways occur in active environmental samples; and 5) identify and evaluate genes involved in 1,4-dioxane biodegradation (Fig.E1). Biodegradation of 1,4-dioxane in environmental samples was performed by utilizing microcosms constructed with samples from two hydrogeochemically different 1,4-dioxane-contaminated aquifers. The 1,4-dioxane biodegradation pathways have been determined by elucidating 1,4-dioxane degradation products produced by strains ENV425, ENV473, and ENV478. Results of this project will lead to 1) a better understanding of the fate of 1,4-dioxane in the environment; 2) analytical tools for evaluating 1,4-dioxane degradation in aquifers; and 3) new treatment approaches for enhancing *in situ* 1,4-dioxane biodegradation.

Results. Biodegradation of 1,4-dioxane by naturally occurring bacteria was evaluated by performing microcosm studies with samples from two different aquifers, and by performing enrichment culturing with samples from these sites, and from two other sites. Microcosms were incubated under aerobic, nitrate reducing, iron reducing, sulfate reducing, and methanogenic conditions. Some microcosms received sodium lactate, molasses, or vegetable oil to simulate anaerobic biostimulation of chlorinated solvent degradation. Likewise, some aerobic microcosms received propane or tetrahydrofuran, known co-substrates for 1,4-dioxane degradation, while others received *Pseudonocardia* sp. strain ENV478 or *Rhodococcus* sp. strain ENV425 to simulate *in situ*

bioaugmentation. 1,4-dioxane was not degraded in any of the anaerobic microcosms during >400 days of incubation. Some 1,4-dioxane degradation was observed in microcosms from Elkton, MD that had been stimulated with propane. Degradation in these microcosms was not apparent until >100 days of incubation, and an additional spike of 1,4-dioxane was not fully degraded. 1,4-dioxane also was degraded in microcosms augmented with strain ENV478 or strain ENV425 plus propane. Several repeat additions of 1,4-dioxane were degraded by strain ENV478, but repeated additions were not well degraded in microcosms augmented with strain ENV425 plus propane. Unfortunately, the difficulty of growing ENV478, its requirement for THF for prolonged activity, and its tendency to form dense cell clumps would likely limit its utility as a biocatalyst for *in situ* treatment of 1,4-dioxane.

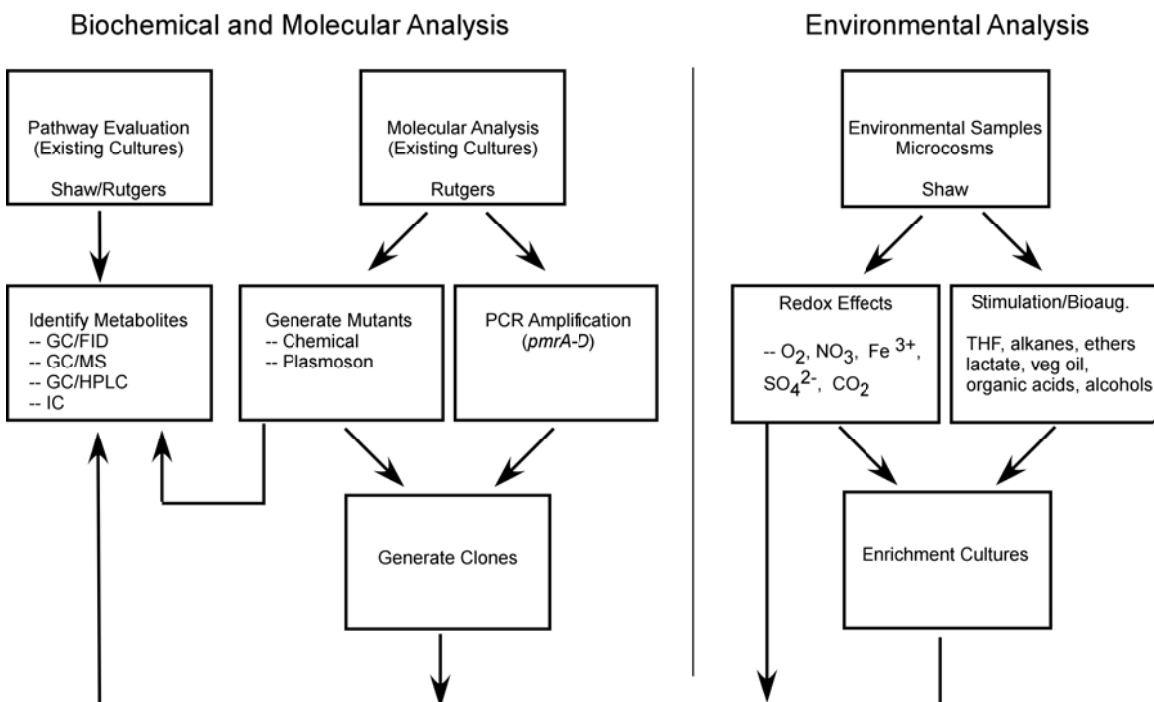

Figure E1. Diagram of proposed work plan

Results of our environmental analysis suggests that 1,4-dioxane still is not degraded in environmental samples. Results of our pathway analysis studies (Fig.E2) suggest that degradation of 1,4-dioxane results in the production of another ether-containing compound (2HEAA) that is not further degraded by the 1,4-dioxane bacteria studied here. In addition, studies with THF-degrading bacteria like strain ENV478 suggested that 1,4-dioxane may be a poor inducer of 1,4-dioxane degradation genes. Studies with strain CB1190 (Parales et al., 1994) suggest that under certain conditions, such as prolonged exposure to 1,4-dioxane in the presence of THF, mutations may occur mutations that will allow the cells to grow on 1,4-dioxane. Therefore, our results suggest that biological treatment, in the absence of biostimulation with propane or THF, may still not be a suitable treatment alternative for 1,4-dioxane. Furthermore, the recalcitrance of 1,4-dioxane under both aerobic and anaerobic conditions suggests that natural biological

techniques, including alleviating potentially problematic gene structures such as resolving overlapping reading frames, substituting less than favorable ribosomal binding sites and start codons with better ones, employing strong expression systems (pET3A plasmids) and using modified hosts with increased capacity to translate infrequently used codons. Using SDS-PAGE analysis we were able to show that the peptides of interest were being produced (in the case of ThfMO) in the heterologous hosts, but no catalytic activity was observed. Accordingly, we tried other approaches including transferring the genes to broad host vectors and using different expression hosts including *P. putida* and *M. smegmatis*. Still, the cloned SDMO genes could not be functionally expressed. We have noted that while several soluble diiron monooxygenases have been cloned and expressed in *E. coli*, there are many that can not yet be expressed successfully. Among these are the methane monooxygenase of *M. trichosporium* OB3b, the *thm* cluster of *Pseudonocardia* sp. strain K1, the *prm* cluster of *Gordonia* TY-5 (Kotani et al., 2003), the alkene monooxygenases of *Rhodococcus* rhodocorus B-276, *Mycobacterium* sp. strain M156 and *Xanthobacter autotrophicus* PY2, and during this study the THF and PMO clusters of strains ENV478 and ENV425.

Summary. Results of this study demonstrated the recalcitrance of 1,4-dioxane. Although several organisms were shown to degrade 1,4-dioxane via cometabolism during growth on propane or THF, 1,4-dioxane was not degraded in microcosms created with samples from two different aquifers regardless of the redox conditions employed. Likewise, 1,4-dioxane was not degraded in samples from 2 different treatment systems that had been exposed to 1,4-dioxane for extended periods. No bacteria that could grow on 1,4-dioxane were enriched or isolated from the 4 systems tested. Therefore, results of this study demonstrate that biological treatment and natural biological attenuation are unlikely to be successful remedial alternatives for 1,4-dioxane contaminated sites.

During this project we did complete the first elucidation of a bacterial biodegradation pathway for 1,4-dioxane. Each of the strains tested co-metabolically degraded 1,4-dioxane after growth on either propane or THF. 1,4-dioxane degradation resulted in the production of 2HEAA that was not further oxidized by the strains tested, although it was degraded by other organisms and in environmental samples. From these studies we conclude that the inability to metabolize 2HEAA, and thereby generate energy to support the oxidation of 1,4-dioxane, is likely a significant contributing factor preventing biological degradation of 1,4-dioxane. Likewise, the inability of 1,4-dioxane to induce propane and THF monooxygenase genes may also contribute to the recalcitrance of 1,4-dioxane.

Extensive molecular biological analysis of 1,4-dioxane degrading bacteria revealed that each of them produced multiple and diverse monooxygenase enzymes, many of which are induced during growth on their primary substrates. Although none of the cloned genes could be functionally expressed in heterologous hosts strains, evidence generated suggested that broad substrate soluble diiron monooxygenase enzymes are the most likely catalysts of co-metabolic 1,4-dioxane degradation.

Table of Contents

EXECUTIVE SUMMARY	i
Introduction	i
Project Goals	ii
Results	ii
Summary	v
List of Tables.....	viii
List of Acronyms and Abbreviations	x
Chemicals	x
Enzymes	x
Other.....	x
I. INTRODUCTION	1
I. A. Background	2
Potential Source Areas for Emergent Chemicals Associated with Solvent Release.....	2
I. B. 1, 4- Dioxane Biodegradation	3
I. C. Potential for In Situ Biotreatment of 1, 4-Dioxane	3
I. D. 1, 4-Dioxane Biodegradation Pathway.....	6
II. ENVIRONMENTAL ANALYSIS	9
II. A. Introduction.....	9
II. B. Sample Collection and Microcosm Studies	9
II. C. Microcosm Setup and Incubation.....	10
II. C. 1. Redox microcosm treatability test	10
II. C. 2. Anaerobic biostimulation treatment	11
II. C. 3. Co-metabolism and bioaugmentation	11
II. C. 4. Stringfellow Site.....	16
II. C. 5. SLAC Site.....	20
II. D. Summary of Environmental Analysis.....	20
III. MOLECULAR AND BIOCHEMICAL ANALYSIS	22
III. A. Introduction	22
III. B. Methods	23
III. B. 1. Isolation and maintenance of organisms of interest	23
III. B. 2. Chemicals.....	24
III. B. 3. Analytical Methods.....	24
III. B 3a. Analytic techniques for monitoring the degradation of 1,4-dioxane and its metabolites	24
III. B. 3b. DNA and RNA Techniques	25
III. B. 3c. Standard PCR.....	25

III. B. 3d. DNA Hybridization	25
III. B. 3e. Quantitative Reverse Transcriptase PCR	25
III. B. 3f. 16s rRNA Analysis	25
III. B. 3g. DNA Sequence Analysis	26
III. B. 3h. 5' RACE Assay	26
III. B. 3i. Gene Cloning	26
III. B. 3j. Transformation of Competent Cells	26
III. B. 3k. Protein Purification and Protein Sequencing	26
III. C. Molecular analysis results	27
III. C. 1. Strain ENV478	27
III. C. 2. Biodegradation of 1,4-Dioxane	28
III. C. 3. 1,4-Dioxane Degradation Pathways Analysis	30
III. C. 4. Molecular Analysis	31
III. C. 4a. <i>Pseudonocardia</i> sp. Strain ENV478	31
III. C. 4a1. PCR based probing for monooxygenase sub-groups	31
III. C. 4a2. Cloning and expression of the <i>thf</i> operon of ENV478	33
III. C. 4a3. Creating a synthetic <i>thf</i> operon	34
III. C. 4a4. Alternative approaches	36
III. C. 4b. <i>Rhodococcus</i> sp. Strain ENV425	37
III. C. 4b1. PCR based probing for monooxygenase sub-groups	37
III. C. 4c. <i>Mycobacterium</i> sp. Strain ENV421	39
III. C. 4c1. Molecular analysis	39
III. C. 4c2. P450 analysis	39
III. C. 4c3. The membrane bound diiron containing monooxygenase (AlkB)	41
III. C. 4c4. Propane monooxygenase	42
III. C. 4d. Metabolism of 2HEAA by organisms that grow on linear ethers	43
III. C. 4e. Superoxide Dismutase (SOD)	47
III. D. Discussion of Molecular Biological Studies	49
III. D. 1. Analysis of the 1,4-dioxane biodegradation pathways	49
III. D. 2. Analysis of 1,4-dioxane degradation genes	52
III. E. Molecular Analysis Conclusion	55
IV. SUMMARY	56
V. REFERENCES	57
Appendix 1. PCR Primers Used in This Study	63
Appendix 2. Vainberg et al., 2006	66
Appendix 3. McClay et al. Submitted to Appl. Environ. Microbiol.	73

List of Tables

Table 1.	Setup of New York Site Redox Microcosms.....	10
Table 2.	Setup of Biostimulation Microcosms.....	11
Table 3.	Setup of Co-metabolism and Bioaugmentation Microcosms	12
Table 4.	Increase in the Total Soluble Solids following growth on THF and/ dioxane	19
Table 5.	Strains and plasmids used in this study	23
Table 6.	Proposed functions of genes in the <i>thf</i> operon of strain ENV478.....	33
Table 7.	Partitioning of 2HEAA derived [¹⁴ C] carbon by <i>Ralstonia sp.</i> strain ENV482.....	43
Table 8.	Oxygenases produced during growth on substrates that promote 1,4-dioxane degradation.	53

List of Figures

Figure 1.	Diagram of proposed work plan.....	1
Figure 2.	Biodegradation of 1,4-dioxane by environmental isolate strain ENV478 after growth on different carbon sources	5
Figure 3.	Potential biodegradation pathways for 1,4-dioxane.....	6
Figure 4.	Dioxane degradation in microcosms under different conditions.....	16
Figure 5.	Degradation of dioxane by the tertiary enrichment culture during growth on THF.....	17
Figure 6.	Degradation of 1,4-dioxane in the presence of different quantities of the co- substrate THF.....	18
Figure 7.	Dendrogram showing the phylogenetic relationship of strain ENV478 to closely related <i>Pseudonocardia</i> strains.....	28
Figure 8.	Simultaneous biodegradation of 1,4-dioxane and THF by strain ENV478 when the compounds were added alone or as a 50:50 mixture.....	29
Figure 9.	Proposed pathway for biodegradation of 1,4-dioxane by THF, toluene, and propane oxidizing organisms.....	31
Figure 10.	Elution profile of the metabolites resulting from transformation of [¹⁴ C] 1,4- dioxane by strain ENV478 and toluene-4-monooxygenase.....	32
Figure 11.	Analysis of the transcriptional organization of the <i>thf</i> operon of strain ENV478.....	33
Figure 12.	Quantitative-RT-PCR analysis of expressions indicated that both of these operons are up-regulated (~32-fold) in the presence of THF.....	34
Figure 13.	SDS-PAGE analysis of the individual <i>thf</i> operon peptides.....	35
Figure 14.	Schematic of the non-replicative plasmid constructed for inactivating the <i>thmB</i> gene of ENV478.....	36
Figure 15.	RT-PCR showing the differential expression of the PMO of strain ENV425 in response to different growth substrates or amendments.....	37

Figure 16.	Phylogenetic analysis of diiron containing monooxygenases related to the PMOs investigated in this study.....	38
Figure 17.	Gene organization of the PMO operon of ENV425.....	38
Figure 18.	SDS-PAGE separation of cytosolic proteins extracted from propane and succinate grown <i>Mycobacterium</i> sp. strain ENV421.....	40
Figure 19.	Gene organization of the P450 gene cluster of <i>Mycobacterium</i> sp strain ENV421.....	41
Figure 20.	Genetic organization of the alkB operon of ENV421 and <i>P. putida</i> GPO1...42	
Figure 21.	Growth of <i>Ralstonia</i> sp. strain ENV482 on 2HEAA.....	44
Figure 22.	Growth of <i>Xanthobacter</i> sp. strain ENV481 on 2HEAA.....	44.
Figure 23.	Inhibition of 2HEAA degradation by ENV481 in the presence of common monooxygenase inhibitors.....	45
Figure 24.	Degradation of 2HEAA in the absence of oxygen with ENV481.....	45
Figure 25.	Differential production of peptides in the presence of linear ether substrates by ENV481 and ENV482.....	46
Figure 26.	Amino acid alignment of the super oxide dismutases of <i>Pseudonocardia</i> sp. K1 and <i>Bacillus cereus</i>	47
Figure 27.	Crystal structure of Super Oxide Dismutase (SOD).....	48
Figure 28.	Biodegradation of 1,4-dioxane in aerobic aquifer microcosms.....	52

List of acronyms and abbreviations

Chemicals

BCEE	<i>bis</i> -(2-chloroethyl)ether
DGA	diglycolic acid
GBL	gamma-butyrolactone
2HEAA	2-Hydroxy-ethoxy-acetic acid
2HTHF	2-Hydroxy-tetrahydrofuran
MTBE	methyl <i>tert</i> -butyl ether
PDX	1,4-dioxane-2-one
PEG	polyethylene glycol
TBA	<i>tert</i> -butyl alcohol
THF	tetrahydrofuran

Enzymes

AlkB	alkane monooxygenase (MBMO)
CAD	chloroacetaldehyde dehydrogenase
MMO	methane monooxygenase (SDMO)
MBMO	membrane bound diiron monooxygenase
SDMO	soluble diiron monooxygenase
ThfMO	tetrahydrofuran monooxygenase (SDMO)
T4MO	toluene-4-monooxygenase (SDMO)
PMO	propane monooxygenase (SDMO)
P450	cytochrome P450 monooxygenase
SOD	superoxide dismutase

Other

BSM	basal salts medium
CBB	Comassie brilliant blue
CO ₂	carbon dioxide
DNA	deoxyribonucleic acid
DOD	Department of Defense
DOE	Department of Energy
ESTCP	Environmental Security Technology Certification Program
FBR	fluidized bed reactor
GAC	granular activated carbon
GC	gas chromatography
HPLC	high pressure liquid chromatography
IC	ion chromatography
IPTG	isopropylthio-b-galactopyranoside
LB	Lauria-Bertani medium
NADH	nicotinamide adenine dinucleotide
ORF	open reading frame
PCR	polymerase chain reaction
QA/QC	quality assurance quality control
qPCR	quantitative polymerase chain reaction

RNA	ribonucleic acid
RT-PCR	reverse transcriptase polymerase chain reaction
QRT-PCR	quantitative reverse transcriptase polymerase chain reaction
SDS-PAGE	sodium dodecylsulfate-polyacrylamide gel electrophoresis
SLAC	Stanford Linear Accelerator
TSS	total Suspended Solids
USEPA	United States Environmental Protection Agency
UV	ultra violet
VOC	volatile organic compound

I. INTRODUCTION

I. A. Background.

The specific goals of this project were: 1) to evaluate biodegradation of 1,4-dioxane in environmental samples under different redox and chemical/physical conditions and different treatment regimes; 2) identify and isolate new 1,4-dioxane degrading microbes from environmental microcosms; 3) identify the products of 1,4-dioxane biodegradation by studying degradation pathways in pure bacterial cultures; 4) confirm that the same biodegradation pathways occur in active environmental samples; and 5) identify and evaluate genes involved in 1,4-dioxane biodegradation (Figure 1). Biodegradation of 1,4-dioxane in environmental samples was performed by utilizing microcosms constructed with samples from two hydrogeochemically different 1,4-dioxane-contaminated aquifers. The 1,4-dioxane biodegradation pathway has been determined by elucidating 1,4-dioxane degradation products produced by strains ENV425, ENV473, and ENV478. Results of this project will lead to 1) a better understanding of the fate of 1,4-dioxane in the environment; 2) analytical tools for evaluating 1,4-dioxane degradation in aquifers; and 3) new treatment approaches for enhancing *in situ* 1,4-dioxane biodegradation.

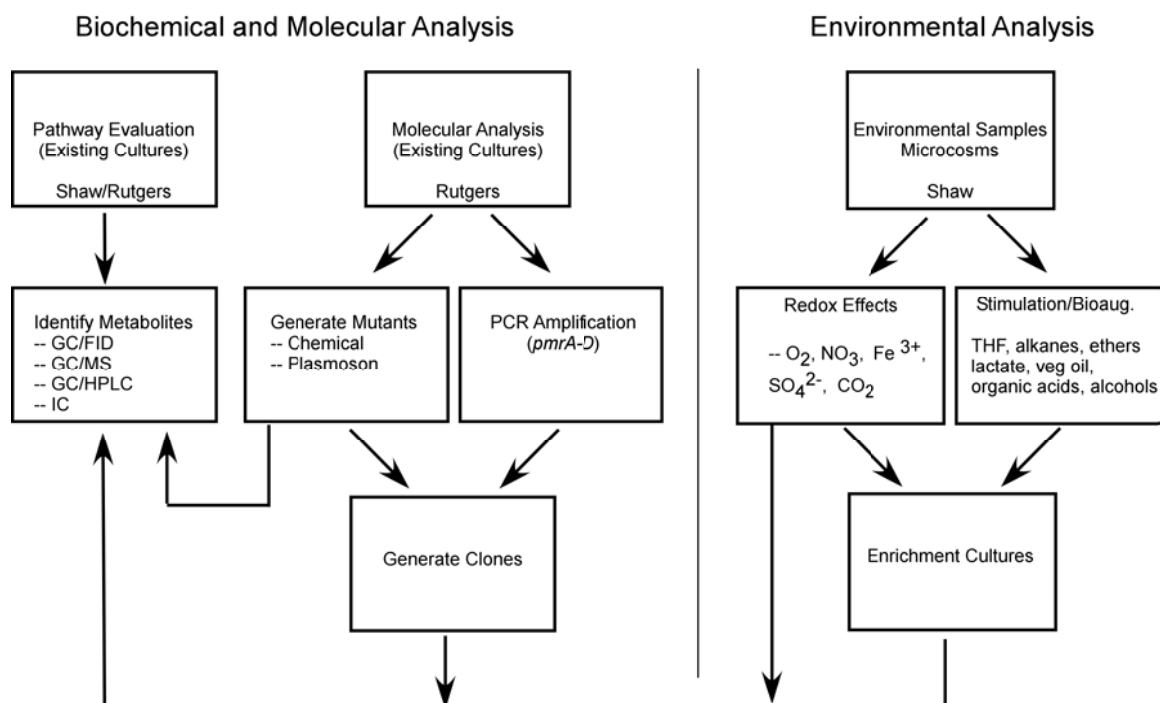

Figure 1. Diagram of proposed work plan.

1,4-dioxane has been used extensively as a stabilizing agent in chlorinated solvents such as 1,1,1-TCA, and it has recently emerged as an important groundwater contaminant throughout the United States and elsewhere. Because of its miscibility in water, its low Henry's Law constant (4.9×10^{-6} atm m³/mol), and low octanol/water partitioning coefficient (K_{oc} 1.23), it is poorly retarded in aquifers. As a result, this compound has the potential to create large contaminant plumes and to threaten drinking water supplies distant from the original release sites (Jackson and Dwarakanath, 1999; Priddle and Jackson, 1991). It has only recently been added to the list of pollutants that must be regularly monitored in several states. Advisory action levels for 1,4-dioxane have been set at very low levels in many states, including, California, 3 ppb; Florida, 5 ppb; Maine, 70 ppb; Massachusetts, 50 ppb; Michigan, 1 ppb; and North Carolina, 7 ppb. Similarly, the EPA issued a health-based advisory level of 3 parts per billion (ppb) for drinking water.

Because chlorinated solvents have been widely used as cleaning solvents within the DOD and DOE, many DOD and DOE sites that have chlorinated solvent contamination also likely are contaminated with 1,4-dioxane. The possibility that the widespread occurrence of 1,4-dioxane in groundwater could result in the re-evaluation and re-opening of chlorinated solvent sites within the DOD and DOE complexes has highlighted the need to evaluate the fate of this compound in the environment and to identify new and effective treatment approaches (Mohr, 2001). The California Regional Water Quality Control Board (2003) requested that the DoD assist in identifying 1,4 dioxane sources at military bases in the State, and identified the following list of sites for evaluation.

Potential Source Areas for Emergent Chemicals Associated with Solvent Release Sites

- Catch basins, waste sumps, clarifiers, and settling ponds,
- Paint maintenance, hobby shops, plating shops, and degreasing activities,
- Weapons maintenance or cleaning areas,
- Known release sites, as appropriate, and
- Suspected areas where these chemicals were stored, used, transferred, processed, incinerated, or disposed.

Few treatment methods have proven successful and economically feasible for removing 1,4-dioxane from groundwater. Because of its low K_{oc} and Henry's Law constant traditional remediation technologies like carbon adsorption and air stripping are inefficient and costly (Bowman et al., 2001). Likewise, *in situ* and *ex situ* biological treatments of 1,4-dioxane have not yet emerged as viable treatment options even though some microbes have been shown to degrade the compound. Only a few *ex situ* technologies including chemical oxidation with combined addition of ozone and hydrogen peroxide (Adams, et al., 1994; Bowman et al., 2001) or hydrogen peroxide and

UV light (Stefan and Bolton, 1998) have been utilized commercially to destroy 1,4-dioxane, but the cost of applying these technologies to high concentration waste streams can be prohibitive.

I. B. 1,4-Dioxane Biodegradation.

Relatively few studies have evaluated biological degradation of 1,4-dioxane, but indigenous microorganisms typically are not able to degrade this compound (Fincher and Payne, 1962; Francis et al., 1980; and Howard, 1990). In the last several years, however, 1,4-dioxane biodegradation has been reported in both pure (Parales et al. 1994; Burbach and Perry 1993; Bernhardt and Diekmann 1991) and mixed cultures (Cowan et al., 1994; Zenker et al., 2000). For example, a pure culture of *Mycobacterium vaccae* JOB5 was shown to partially degrade 1,4-dioxane, but not to grow on the compound (Burbach and Perry 1993). Likewise, Bernhardt and Diekmann (1991) reported the biodegradation of 1,4-dioxane as the sole carbon and energy source by a *Rhodococcus* strain, and Parales et al. (1994) isolated the only bacterium (strain CB1190) to date that is capable of sustained growth and mineralization of 1,4-dioxane, albeit at low rates. In other studies, mixed cultures of bacteria were able to degrade 1,4-dioxane, but only in the presence of the co-substrate tetrahydrofuran (THF) (Cowan et al., 1994; Zenker et al., 2000). Little or no controlled research has been done to evaluate 1,4-dioxane degradation under redox conditions that are common in aquifers (e.g., iron reducing, sulfate reducing, and methanogenic), or to evaluate the effect of co-contaminants or biostimulation additives (e.g., lactate; molasses, vegetable oils) on 1,4-dioxane degradation.

We have recently identified three new pure bacterial cultures that can rapidly degrade 1,4-dioxane (Vainberg et al., 2006). Strain ENV425 is able to degrade 1,4-dioxane after growth on either THF or propane, and it also degrades the non-symmetrical alkyl ether methyl-*tert*-butyl ether (MTBE; Steffan et al., 1997). Strains ENV478 and ENV473 also degrade 1,4-dioxane after growth on THF, but strain ENV478 has the unique ability to degrade 1,4-dioxane after growth on non-toxic carbon sources including lactate, sucrose, and isopropanol (Figure 2). Growth of ENV478 on THF is enhanced in the presence of 1,4-dioxane, suggesting that the strain obtains metabolic carbon and energy from 1,4-dioxane. These studies suggest that 1,4-dioxane degraders may be more widespread in nature than commonly thought, and that a better understanding of the physiology of these organisms and the biochemistry of 1,4-dioxane biodegradation may lead to advanced treatment options for this recalcitrant pollutant. We also have successfully demonstrated that 1,4-dioxane can be treated in bioreactors inoculated with these strains if THF or propane are added to support the growth and activity of the organisms (See Supporting Data).

I. C. Potential for In Situ Biotreatment of 1,4-Dioxane

Although it may not be practical to utilize THF as an inducer for *in situ* 1,4 dioxane treatment, this may not be necessary. For example, Strain ENV478 has been shown by us

to degrade 1,4-dioxane after growth on common bacterial carbon sources including yeast extract, lactate, and sucrose (Figure 2). Thus it is possible that organisms with similar capabilities reside in contaminated aquifers. If so, the growth and 1,4-dioxane degrading activity of these microbes might be supported simply by providing adequate nutrients such as oxygen, carbon, nitrogen and phosphorous. Likewise, studies by Hyman and colleagues (Johnson et al., 2004; Smith et al., 2003) have shown that degradation of another ether contaminant, MTBE, which is considered to be co-metabolically degraded, can be biodegraded even in the absence of the enzyme-specific inducer. They showed that alkane-oxidizing bacteria that can degrade MTBE after growth on alkanes (Steffan et al., 1997) could also degrade MTBE in the presence of alkane oxidation products (alcohols and organic acids) because these products can induce the alkane oxidation enzymes responsible for MTBE degradation and provide the metabolic energy needed for MTBE biodegradation (Smith et al., 2003). This data has led to the conclusion that MTBE can be degraded *in situ* in gasoline-contaminated sites where hydrocarbon degradation products are present, as long as sufficient oxygen is available. Similarly, these researchers demonstrated that MTBE may be able to induce the alkane oxidation enzymes while the bacteria utilize alternative carbon sources to supply the energy necessary for MTBE degradation (Johnson et al., 2004). Thus, in the case of 1,4-dioxane, it is possible that the presence of alternative carbon sources can support 1,4-dioxane degradation by either inducing 1,4-dioxane degrading enzymes and providing energy, or by providing energy to 1,4-dioxane degrading enzymes that are themselves induced by 1,4-dioxane. This hypothesis is probable because the same organisms that degrade MTBE via an alkane monooxygenase (e.g. *Mycobacterium vaccae* JOB5, and *Rhodococcus ruber* ENV425) degrade 1,4-dioxane by the same alkane monooxygenase mechanism (Steffan et al., 1997).

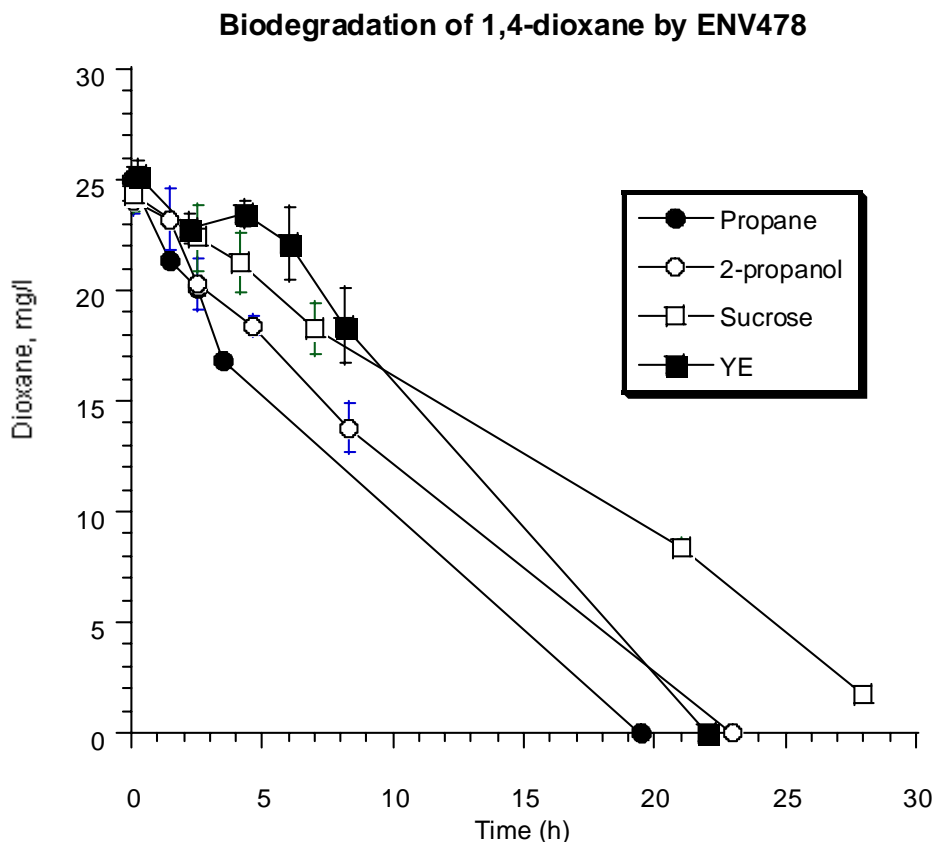

Figure 2. Biodegradation of 1,4-dioxane by environmental isolate strain ENV478 after growth on different carbon sources. This demonstrates that ENV478 is one of the first organisms isolated that can degrade 1,4-dioxane without a specific co-metabolic substrate or inducer.

An alternative approach for 1,4 dioxane remediation may be to use a co-metabolic *in situ* treatment system that utilizes gaseous alkanes (typically butane or propane) as a co-substrate to support biodegradation. Although such systems can be difficult to operate and optimize, they have been proven safe and effective in some cases. We have successfully applied such a system for degrading MTBE at a New Jersey gasoline station (Steffan et al., 2003).

The potential for anaerobic degradation of 1,4-dioxane also exists. For example, early studies of the anaerobic biodegradation of the asymmetric alkyl ether MTBE (Mormile et al., 1994; Suflita and Mormile, 1993; Yeh and Novak, 1994) suggested that the compound was not degraded under anaerobic conditions. More recent studies, however, have suggested that anaerobic MTBE biodegradation is more widespread than previously thought, including under iron reducing (Bradley et al., 2001b; Finnernan and Lovely, 2001), nitrate reducing (Bradley et al., 2001a); sulfate reducing (Bradley et al., 2001b), and methanogenic (Wilson et al., 2000) conditions. In fact, Bradley and colleagues have commented that they now find MTBE biodegradation “everywhere we look” (Bradley et al., 2001b). These results suggest that anaerobic degradation of other

ethers, including 1,4-dioxane, also may be more widespread in the environment than previously thought.

I. D. 1,4-Dioxane Biodegradation Pathway

Although a few microorganisms are known to degrade 1,4-dioxane (see above), and mechanisms of ether scission have been extensively studied (White et al., 1996), the microbial biodegradation pathway for this compound has not been completely elucidated. Understanding the biodegradation pathway will allow us to identify potential bottlenecks in the degradation pathway that limit 1,4-dioxane degradation, and possibly allow the identification of treatment approaches to minimize these limitations. Similarly, it may lead to the identification of relatively recalcitrant degradation intermediates that can be used as indicators of intrinsic biodegradation in contaminated aquifers.

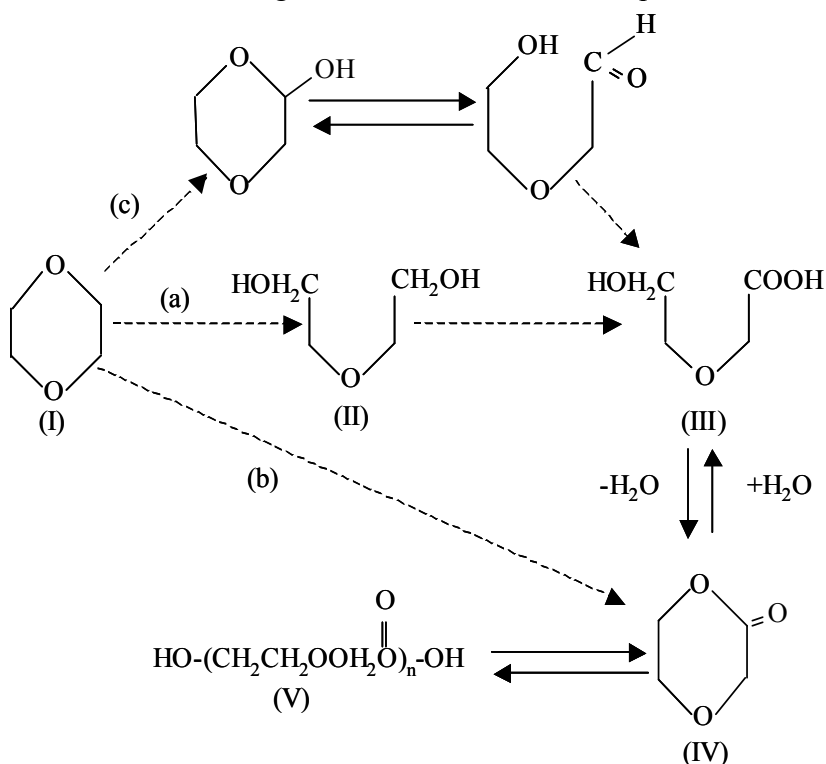

Figure 3. Potential biodegradation pathways for 1,4-dioxane. Derived from Woo et al., (1977), and based on suspected 1,4-dioxane metabolism pathways in rats. Structures are described in the text.

The metabolism of 1,4-dioxane in rats has been studied, and several possible pathways exist (Figure 3). Similar biodegradation pathways likely occur in bacteria. Woo et al. (1977) suggested that *p*-dioxane-2-one (IV) is the major urinary metabolite of dioxane (I) in rats, but suggested that other pathways could exist. Examples of other pathways include: (a) hydrolysis to diethylene glycol (II), followed by oxidation of one of the hydroxyl groups, (b) direct conversion via a possible ketoperoxy radical

intermediate similar to the reaction scheme proposed by Lorentzen et al. (1975) for the oxidation of the carcinogen, benzo[a]pyrene to benzo[a]pyrene diones, and (c) through beta-hydroxylation, followed by the oxidation of the mediacetal or hydroxyaldehyde intermediate. Braun and Young (1977), using a different approach, identified beta-hydroxyethoxyacetic acid (III) as the major metabolite. It should be noted, however, that beta-hydroxyacids rarely exist as such in the pure state or in aqueous solution except in the form of salts, but rather the majority of the acids of this type are known only in the form of the lactone. Thus, lactonization of the 2-hydroxyethoxyacetic acid (III) could result in production of the *p*-dioxane-2-one (IV). The compound *p*-dioxane-2-one (IV) can spontaneously polymerize to linear polymers (V), or it can be reversibly converted to 2-hydroxyethoxyacetic acid (III) under acetic or basic conditions. In related work Hyman (1999) demonstrated that alkane oxidizing bacteria convert tetrahydrofuran and tetrahydropyran, related cyclic ethers, to their corresponding lactones, butyrolactone and valerolactone, respectively. The cultures grew well on the lactones and their hydroxy acid derivatives, but not on the ethers. Interestingly, *p*-dioxane-2-one (IV) has been used industrially as a preservative, suggesting that it may be a toxic metabolite of 1,4-dioxane at some concentration. The fate of these degradation products in the environment has not been investigated, but some (e.g., *p*-dioxane-2-one and its linear polymers) may be relatively recalcitrant leading to their use as indicators of intrinsic 1,4-dioxane biodegradation.

Ether-containing organic compounds are widely used as solvents, pesticides, gasoline additives, and a host of other applications. Most recently, the solvent stabilizer 1,4-dioxane has emerged as an important groundwater contaminant throughout the United States and elsewhere (Mohr, 2001). Typical of many ethers, it is miscible in water, has a low dimensionless Henry's Law constant (2.0×10^{-4}), and low octanol/water partitioning coefficient (K_{oc} 1.23), resulting in it being poorly retarded in aquifers resulting in the potential to create large contaminant plumes that threaten drinking water supplies distant from the original release sites (Priddle and Jackson, 1991; Jackson and Dwarakanath, 1999; Lesage et al., 1990).

Few treatment methods have proven successful and economically feasible for removing 1,4-dioxane from groundwater. Because of its low K_{oc} and Henry's Law constant traditional remediation technologies like carbon adsorption and air stripping are inefficient and costly. Likewise, *in situ* and *ex situ* biological treatments of 1,4-dioxane have not yet emerged as viable treatment options even though some microbes have been shown to degrade the compound. Only a few *ex situ* technologies including chemical oxidation with combined addition of ozone and hydrogen peroxide (Adams, et al., 1994) or hydrogen peroxide and UV light (Stefan and Bolton, 1998) have been utilized commercially to destroy 1,4-dioxane, but the cost of applying these technologies to high concentration waste streams can be prohibitive.

Relatively few studies have evaluated biological degradation of 1,4-dioxane, but indigenous microorganisms at contaminated sites often are not able to degrade this compound (Fincher and Payne, 1962; Lesage et al., 1990). In the last several years, however, 1,4-dioxane biodegradation has been reported in both pure (Parales et al. 1994;

Burback and Perry 1993; Bernhardt and Diekmann 1991) and mixed cultures of bacteria (Klečka and Gonsior, 1986; Zenker et al., 2000), and by a fungal isolate (Nakamiya, et al., 2005). For example, a pure culture of the propane oxidizing bacterium *Mycobacterium vaccae* JOB5 was shown to partially degrade 1,4-dioxane, but not to grow on the compound (Burback and Perry 1993). Bernhardt and Diekmann (1991) reported the biodegradation of 1,4-dioxane by a *Rhodococcus* strain, and Parales et al. (1994) isolated a bacterium (strain CB1190) that is capable of sustained growth and mineralization of 1,4-dioxane, albeit at low rates. Strain CB1190 has recently been re-classified as *Pseudonocardia dioxanivorans* strain CB1190 (Mahendra and Alvarez-Cohen, 2005). In other studies, mixed cultures of bacteria were able to degrade 1,4-dioxane, but only in the presence of the co-substrate tetrahydrofuran (THF) (Zenker et al., 2000)

Unlike 1,4-dioxane, biodegradation of the cyclic monoether THF has been well studied and it appears to act as a growth substrate for many bacteria (Bernhardt and Diekmann, 1991; Daye, et al., 2003; Kohlweyer, et al., 2000; Parales et al., 1994; Thiemer et al., 2003; Zenker et al., 2000). Detailed molecular and biochemical analysis of THF degradation by *Pseudonocardia* sp. strain K1 led to the cloning of an operon involved in THF degradation and the description of a biodegradation pathway for THF. Initial transformation of THF by strain K1 appears to involve a binuclear-iron-containing multicomponent monooxygenase (ThfMO) that oxidizes THF to 2-hydroxytetrahydrofuran (2HTHF) (Theimer et al., 2001; 2003). The authors further suggested the role of a dehydrogenase to convert 2HTHF to *gamma*-butyrolactone (gBL), a hydrolase to convert gBL to 4-hydroxybutyrate, and a second dehydrogenase to convert 4-hydroxybutyrate to succinate semialdehyde.

Although no bacterial 1,4-dioxane biodegradation pathways have been described, two reports have described 1,4-dioxane degradation in rats. Woo et al. (1977) suggested that 1,4-dioxane-2-one (PDX) is the major urinary metabolite of 1,4-dioxane in rats, but suggested that other pathways could exist. Braun and Young (1977), using a different approach, identified 2-hydroxyethoxyacetic acid (2HEAA) as the major metabolite. *Delta*-hydroxyacids, however, rarely exist as such in the pure state or in aqueous solution except in the form of salts, but rather the majority of the acids of this type are known primarily in the form of the lactone. Thus, lactonization of the 2HEAA would result in production of the PDX as identified in the Woo et al. report (1997). The compound PDX also can polymerize spontaneously to linear polymers, or it can be reversibly converted to 2HEAA under basic conditions. In a study of 1,4-dioxane degradation by a pure culture of filamentous fungi, ethylene glycol was the first 1,4-dioxane product detected, suggesting an alternate degradation pathway (Nakamiya et al., 2005).

The specific goals of this project were: 1) to evaluate biodegradation of 1,4-dioxane in environmental samples under different redox and chemical/physical conditions and different treatment regimes; 2) identify and isolate new 1,4-dioxane degrading microbes from environmental microcosms; 3) identify the products of 1,4-dioxane biodegradation by studying degradation pathways in pure bacterial cultures; 4) confirm that the same biodegradation pathways occur in active environmental samples; and, 5) evaluate the molecular biology and biochemistry of 1,4-dioxane degradation.

Biodegradation of 1,4-dioxane in environmental samples was evaluated by utilizing microcosms constructed with samples from two hydrogeochemically-different 1,4-dioxane-contaminated aquifers, and by performing enrichment culturing of samples from two well known 1,4-dioxane sites. In addition, the 1,4-dioxane biodegradation pathway in bacteria was elucidated by analyzing the 1,4-dioxane degradation products produced by bacterial strains ENV421, ENV425, and ENV478 that are known to co-metabolically degrade 1,4-dioxane. We also hoped to identify any products produced in microcosms and enrichment cultures generated from active microcosms. The ultimate goals of the project were to 1) better understand the fate of 1,4-dioxane in the environment; 2) develop analytical tools for evaluating 1,4-dioxane degradation in aquifers; and 3) identify new treatment approaches for enhancing *in situ* 1,4-dioxane biodegradation.

II. ENVIRONMENTAL ANALYSIS.

II. A. Introduction.

A microcosm study was performed to evaluate aerobic and anaerobic 1,4-dioxane degradation in environments that have experienced prolonged 1,4-dioxane contamination. The goals of the study were to assess the fate of 1,4-dioxane in the environment, and to evaluate methods for enhancing 1,4-dioxane degradation to improve site remediation efforts. The microcosms were established with samples from 2 industrial sites. In addition to the microcosm study, efforts were made to enrich naturally occurring microorganisms that are able to grow on 1,4-dioxane as a sole carbon source. Enrichment culturing was performed with samples from 2 treatment systems that contained granular activated carbon (GAC). GAC is known to be an excellent support for microbial growth, so it was expected that GAC from these systems would have a high probability of containing attached 1,4-dioxane degrading microbes that could be grown to higher cell densities under optimum laboratory conditions.

II. B. Sample Collection and Microcosm Studies.

Aquifer samples were collected from known or potential 1,4 dioxane contaminated sites for use in enrichment and microcosm studies. Four potential sites were identified for sample collection. The first site (named the Elkton site) is located at Elkton, Maryland, and was studied by Dr. Bob Borden of North Carolina State University as part of an ESTCP field demonstration. The site is contaminated with perchlorate and 1,1,1-TCA, and it was expected to contain 1,4-dioxane. As part of the ESTCP project, Dr. Borden and colleagues installed a vegetable oil barrier that effectively reduced *in situ* perchlorate and TCA contamination. The barrier resulted in the creation of a gradient of redox conditions. Therefore, we collected samples across this gradient to collect samples that were naturally aerobic, nitrate reducing, sulfate reducing, or methanogenic.

A second site (the “New York Site”) was that of a Shaw commercial client. The site is heavily contaminated with chlorinated solvents including 1,1,1-TCA. In-house

analysis revealed the existence of 1,4-dioxane (~10-50 mg/L) in the site samples. Shaw was scheduled to perform a pilot project at the site beginning in August, and site samples were collected during installation of the pilot system.

II. C. Microcosm Setup and Incubation.

The soils collected from each site were homogenized separately, passed through a ¼” screen to remove larger rocks and debris, transferred to 950 mL QA/QC bottles with Teflon™-lined lids, and stored at 4 °C until used in microcosm set up. Site ground water from the two 1,4-dioxane contaminated sites was mixed separately, transferred to 4 L jugs with Teflon™-lined caps and stored at 4 °C until used in microcosm set up.

Prior to setting up the microcosms the homogenized site water was analyzed for pH, anions (nitrate, nitrite, sulfate, chloride), ferric iron, VOCs, and 1,4-dioxane. Because the New York Site contained excess VOCs, they were sparged with nitrogen to reduce excess VOCs (TCE, DCE, 1,1,1-TCA).

II. C. 1. Redox Microcosm Treatability Test. The objective of this phase of work was to determine the influence of oxygen, nitrate, nitrite, sulfate, ferric iron, chlorinated solvents (TCE and 1,1,1-TCA) and methanogenic conditions on 1,4-dioxane degradation by natural microflora in subsurface samples. Microcosms from the New York Site were constructed in 140 mL serum vials (160 mL fill volume) with aluminum crimp-sealed with Teflon™-lined butyl rubber septa. All microcosms received 50 g of homogenized soil and 80 mL of site water. Eight sets of quadruplicate microcosms were set up with three designated for analysis and one for a backup. Each aerobic microcosm received 10 mL of pure oxygen in their headspace prior to crimp sealing. An additional three “No Addition” microcosms were constructed, one at the beginning, one in the middle, and one at end of the microcosm setup and sacrificed for initial (time zero) analysis of 1,4-dioxane. Specific electron donors added as redox buffers were added as described in Table 1. Because the Elkton site samples represented a natural redox gradient, no additional electron acceptors were added.

Table 1. Setup of New York Site Redox Microcosms

REDOX CONDITIONS		
Amendment	Final Concentration	No. Microcosms
NO ₃ (as NaNO ₃)	100 ppm	4
NO ₂ (as NaNO ₂)	10 ppm	4
SO ₄ (as Na ₂ SO ₄)	100 ppm	4
Fe(III) (as FeCl ₃)	100 ppm	4
Oxygen	10-16 ml in headspace	4
No Addition Control		7
Killed Control	450 ppm HgCl ₂	4
Total Microcosms		31

Microcosms were incubated on their sides at 15 °C in the dark for up to 400 days and they were shaken vigorously by hand weekly. The microcosms were sampled (10 mL) periodically for 1,4-dioxane analysis. Samples were periodically removed after sampling the microcosm headspace for oxygen and carbon dioxide using a PBI Dansensor CheckPoint O₂/CO₂ Analyzer. After sampling, septa were replaced, fresh oxygen (16 mL) was added to the headspace, and the microcosms were returned to incubate. The timing of the samplings events was based on results from previous samplings.

II. C. 2. Anaerobic biostimulation treatment. A common approach for remediating chlorinated solvents involves the addition of carbon sources that act as electron donors to support reductive dechlorination of the solvents. Microcosms were established with the addition of lactate, molasses, or vegetable oil to evaluate the affect of these materials on the fate of 1,4-dioxane (Table 2). Killed controls also were prepared, and the samples were incubated and analyzed as described above. Biostimulation microcosms were constructed in 140 mL serum vials (160 mL fill volume) and aluminum crimp-sealed with Teflon™-lined butyl rubber septa. All microcosms received 50 g of homogenized soil and 80 mL of Site Water. Five sets of quadruplicate microcosms were be set up with three for analysis and one for a backup. Each microcosm received 10 mL of pure oxygen in the headspace prior to crimp sealing. An additional three “No Addition” microcosms were constructed, one at the beginning, one in the middle, and one at end of the microcosm setup and sacrificed for initial (time zero) analysis of 1,4-dioxane.

Table 2. Setup of Biostimulation Microcosms

BIOSTIMULATION CONDITIONS		
Amendment	Final Concentration	No. Microcosms
Lactate	0.05%	4
Molasses	0.05%	4
Vegetable Oil	0.05%	4
No Addition Control		7
Killed Control	450 ppm HgCl ₂	4
Total Microcosms		23

II. C. 3. Co-metabolism and bioaugmentation. Because 1,4-dioxane is known to be degraded co-metabolically by THF and propane oxidizing organisms (Vainberg et al., 2006), a series of microcosms was constructed to evaluate co-metabolic biodegradation of 1,4-dioxane and the effect of bioaugmentation with strain ENV478 (a THF degrader) or ENV425 (a propane degrader) (Vainberg et al., 2006) on 1,4-dioxane degradation (Table 3). Microcosms were constructed in 140 mL serum vials (160 mL fill volume) fitted with aluminum crimp-sealed with Teflon™-lined butyl rubber septa. All microcosms received 50 g of homogenized soil and 80 mL of Site Water. Twenty-one sets of quadruplicate microcosms were set up with three for analysis and one for a back

up. Each microcosm received 20 mL of pure oxygen in the headspace prior to crimp sealing. An additional three “No Addition” microcosms were constructed, one at the beginning, one in the middle, and one at end of the microcosm setup and sacrificed for initial (time zero) analysis of 1,4-dioxane. Bioaugmentation microcosms received 1 mL of culture at an optical density at 550 nm (OD_{550}) of 16, resulting in a final concentration of $OD_{550}=0.2$.

Table 3. Setup of Co-metabolism and Bioaugmentation Microcosms.

CO-METABOLISM CONDITIONS		
Condition	Final Concentration	No. Microcosms
Propane	20 mL propane	4
Tetrahydrofuran	200 ppm	4
BIOAUGMENTATION CONDITIONS		
Condition	Addition	No. Microcosms
ENV478		4
ENV478 + THF	50 ppm	4
ENV473		4
ENV473 + THF	50 ppm	4
ENV425		4
ENV425 + propane	20 mL propane	4
No Additions		7
Killed	450 ppm $HgCl_2$	4
Total Microcosms		43

Biostimulation and bioaugmentation microcosms were amended with pure oxygen, and additional oxygen was added to the microcosms as needed to ensure aerobic conditions. All microcosms were incubated, sampled and analyzed for 1,4-dioxane and other volatile products as described above. As with all microcosms, after sampling septa were replaced, 16 mL of fresh oxygen and 20 mL of any required gas (propane) was added to the headspace, and microcosms were returned to incubate.

ELKTON GP-1 Microcosms

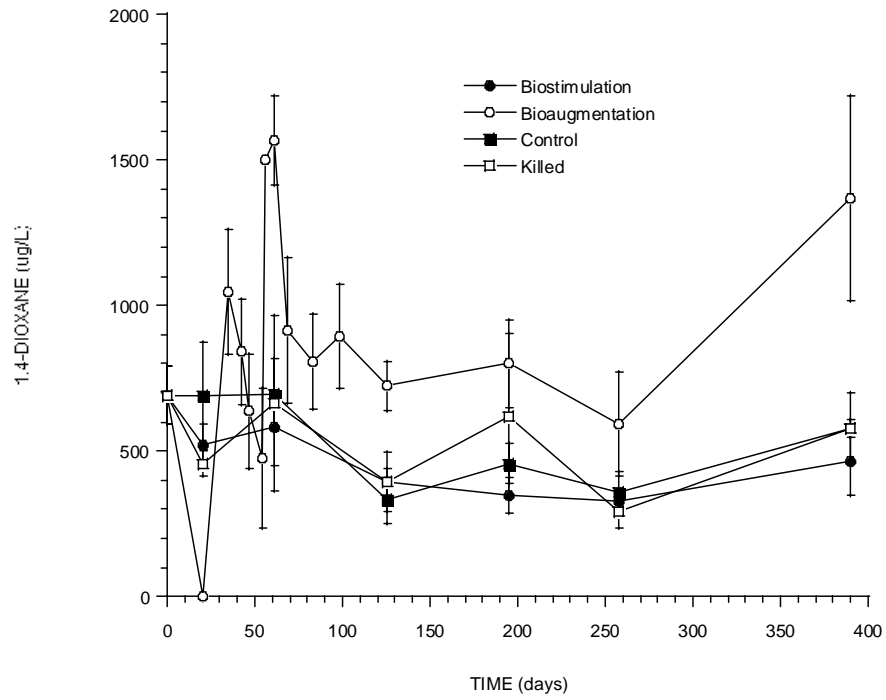

ELKTON GP-2 Microcosms

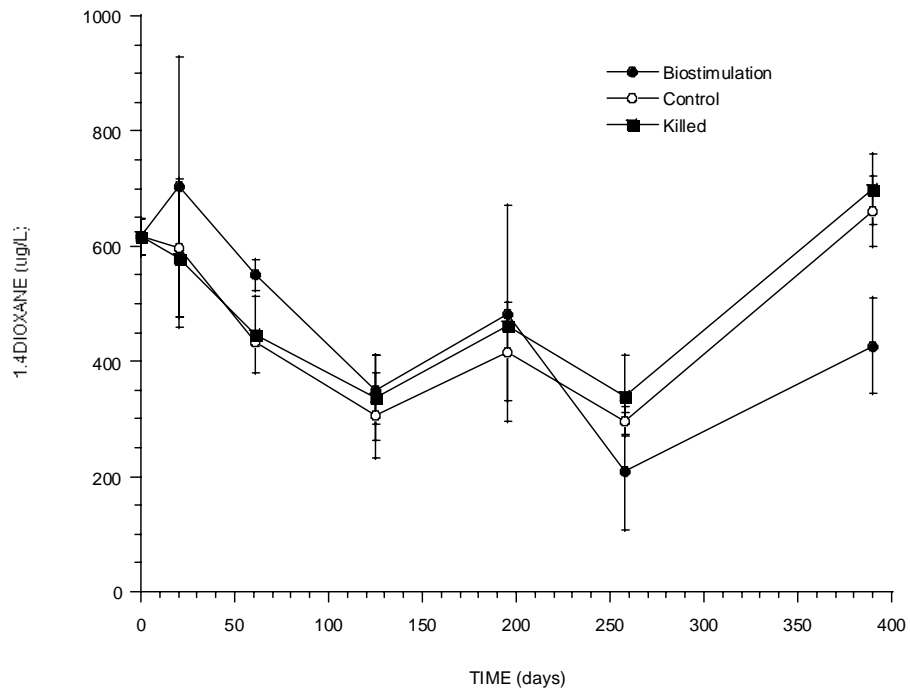

ELKTON GP-3 Microcosms

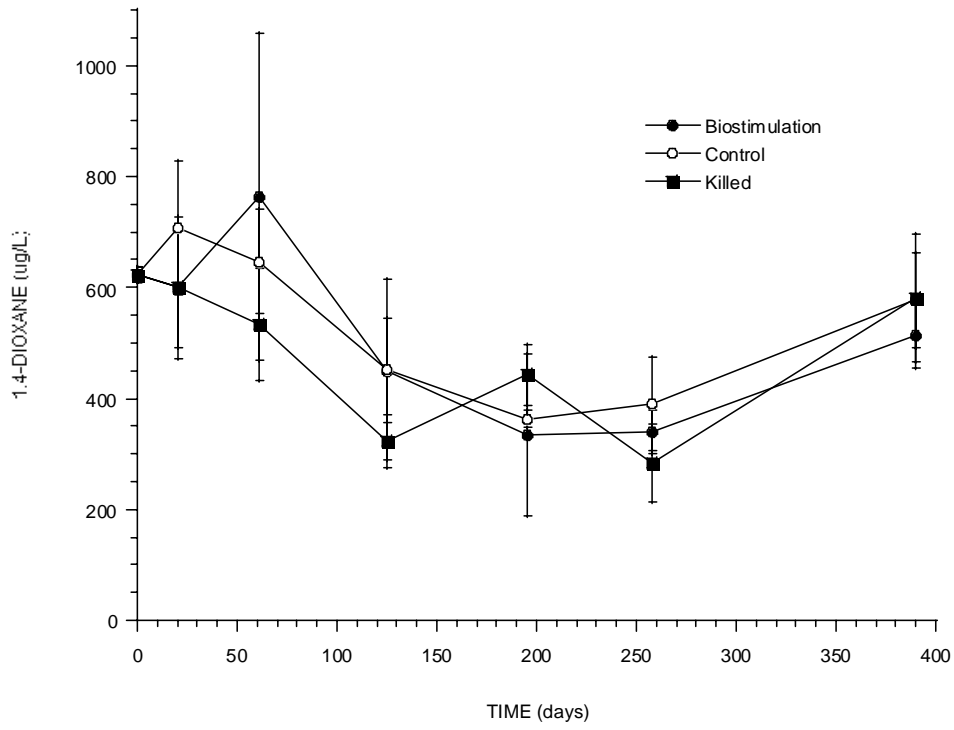

ELKTON GP-5 Microcosms

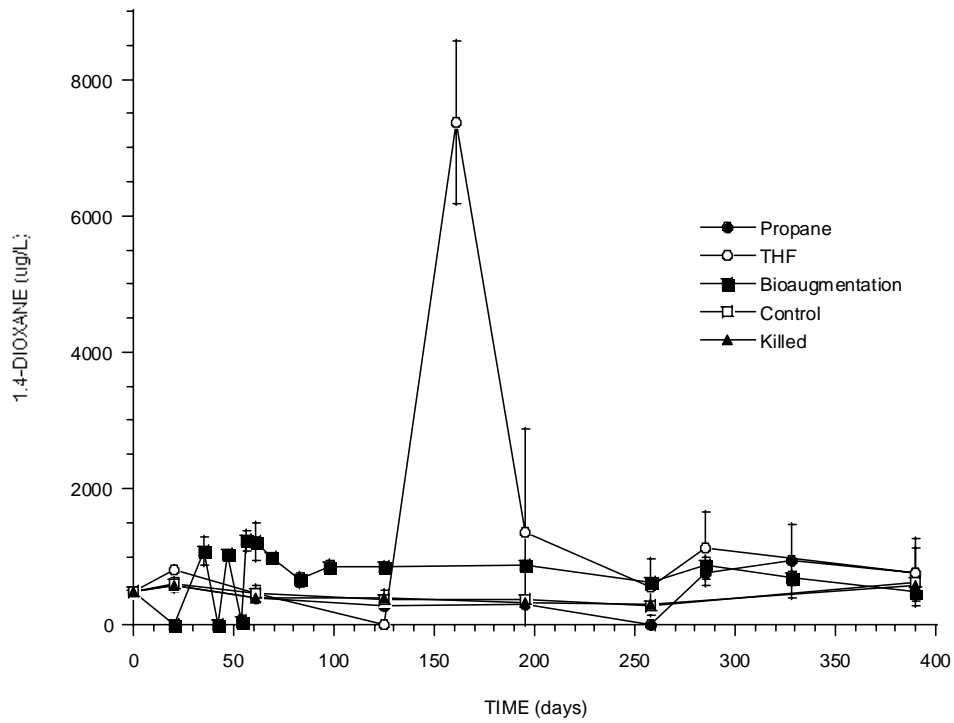

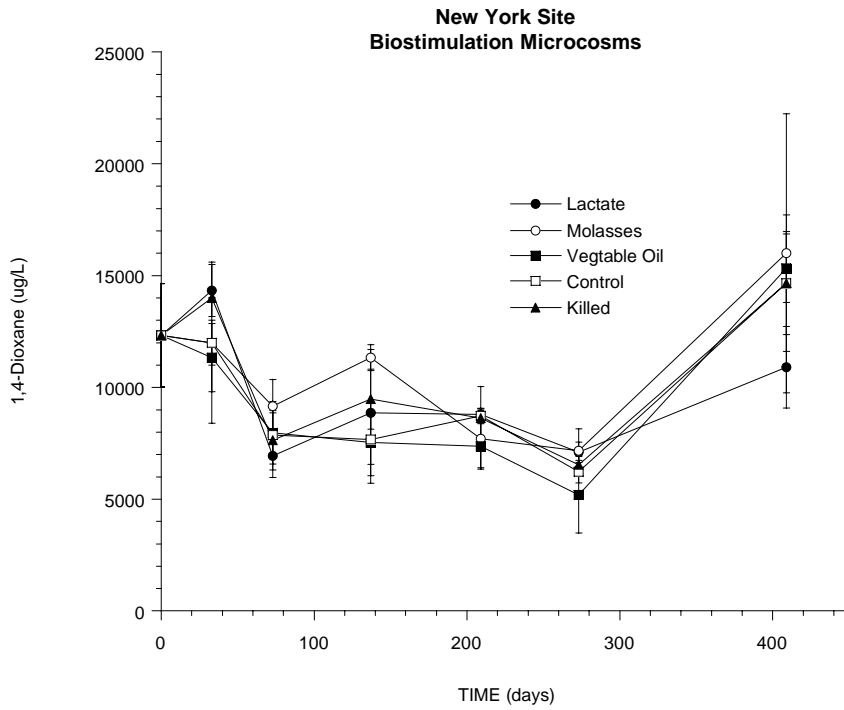
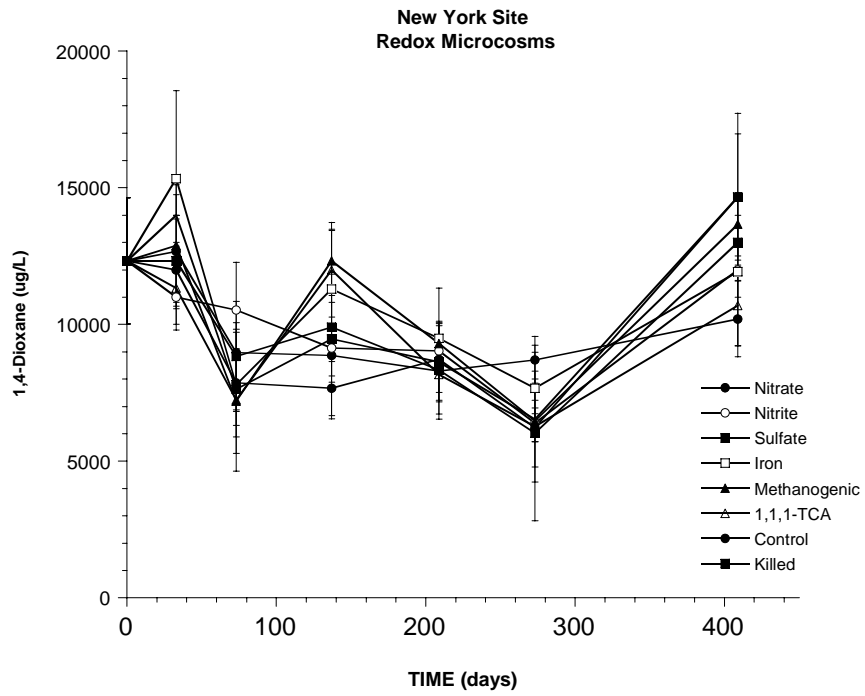

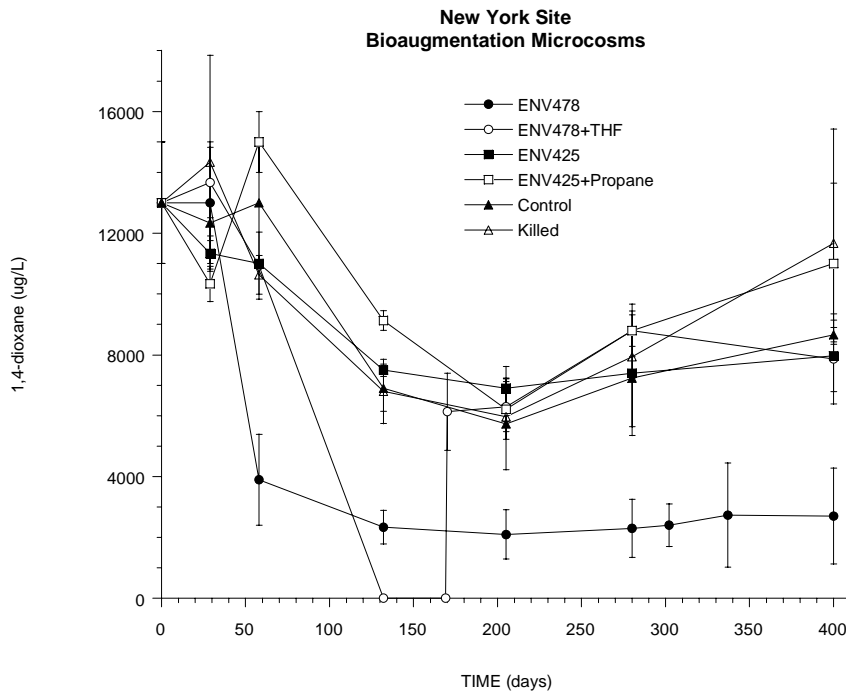

Figure 4. Dioxane degradation in microcosms under different conditions. The microcosms were constructed as described in the text. The conditions used are indicated in the accompanying legends.

II. C. 4. Stringfellow Site. The Stringfellow Site covers 22 acres in a canyon near Glen Avon Heights in southern California. From August 1956 to November 1972, an estimated 34 million gallons of liquid wastes (spent acid, organics, and heavy metals) were dumped into surface impoundments. Heavy rainfall in the past has led to the release of hazardous wastes into the environment. Both surface water and ground water are contaminated. In December 1980, the site reverted to the State for failure to pay back taxes. Since then cleanup activities have begun. In particular, a fluidized carbon bed reactor (FBR) has been employed by Shaw to treat mixed organics. The reactor has performed well for more than 2 years, except that 1,4-dioxane has been passing through the reactor unaltered, at a concentration of < 1 ppm. Granular activated carbon from the Stringfellow FBRs were sent to us to attempt to enrich native 1,4-dioxane degrading microorganisms.

For the initial enrichment of bacterial isolates of interest, approximately 10 grams of water saturated carbon obtained from the Stringfellow FBR was added to 300 ml of basal salts medium (BSM; Hareland et al., 1975) diluted to 50% normal strength with diH₂O in a 2 L flask. 1,4-dioxane and THF were added to the culture to final concentrations of 100 ppm and 20 ppm respectively. The level of dioxane used in these experiments greatly exceeds what is seen in the Stringfellow reactor. The higher

concentrations were chosen to provide a strong impetus for the organisms to acquire the ability to grow on 1,4-dioxane and to make assessing the presence or absence of growth easier. The flask was sealed with a silicon stopper and allowed to incubate with shaking at 32°C. After 3 days, 5-ml aliquots were taken from the large flask and transferred to 30 ml of fresh medium in 120 ml serum vials. 1,4-dioxane was again added to all vials to a final concentration of 100 ppm, along with other amendments that might have been able to stimulate 1,4-dioxane degradation. These amendments consisted of THF, 2HEAA (a 1,4-dioxane metabolite), polyethylene glycol and yeast extract with tryptone. We found that of these amendments, only vials receiving THF were able to degrade 1,4-dioxane.

A secondary enrichment was prepared by transferring 10 ml of the primary enrichment into a second flask that was otherwise identical to the one described for the primary enrichment. The remainder of the primary enrichment was retained and 1,4-dioxane and diglycolic acid were added. The diglycolic acid (DGA) was added because it is structurally similar to 2HEAA but is commercially available, and because previous research had shown that cultures that can grow on DGA can also grow on 2HEAA.

After 7 days, a tertiary enrichment was made by taking 5 ml of the secondary enrichment and adding it to 90 ml of full strength BSM to which 5 µl of THF and 20 µl of dioxane were added. After 4 days there was visible and definitive growth in the tertiary enrichment, but there was also a considerable quantity of dioxane left in the flask, suggesting that the growth was THF dependent and 1,4-dioxane degradation was still a co-metabolic process. Extended incubation of the tertiary enrichment showed that the degradation of dioxane began to level off with time (Figure 5) following the depletion of THF.

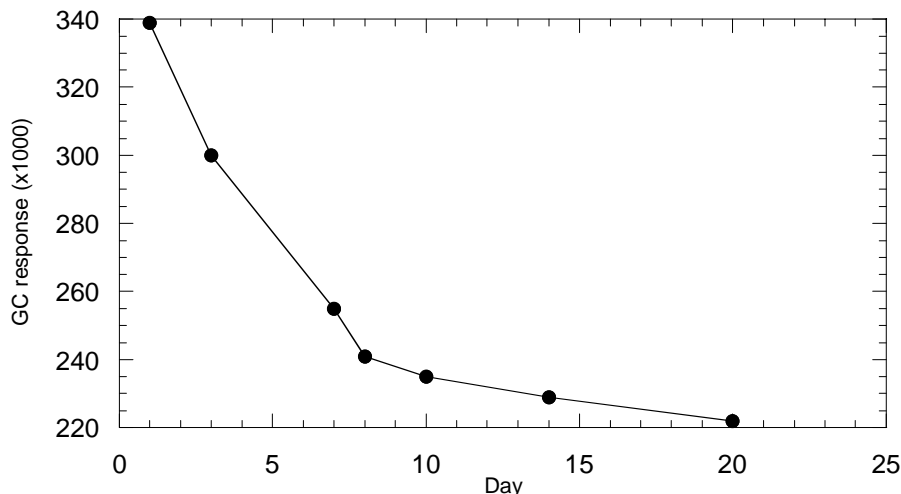

Figure 5. Degradation of 1,4-dioxane by the tertiary enrichment culture during growth on THF.

To ascertain how the presence of THF influenced the degradation of 1,4-dioxane an experiment was designed to follow the degradation of 1,4-dioxane in the presence of various quantities of THF. Flasks were inoculated with enrichment culture and 20 μ l dioxane, along with 0, 5, 10, or 20 μ l of THF. The flasks were monitored via gas chromatography (GC) to determine how long THF persisted and how it influenced the initial rate of dioxane degradation and the amount of 1,4-dioxane that was degraded. We found that THF initially inhibited the degradation of 1,4-dioxane, probably by excluding 1,4-dioxane from the active site of the degradative enzyme, thus cultures that received little or no THF initially degraded 1,4-dioxane faster than cultures that received more THF (Figure 6). This made it appear that less THF led to better 1,4-dioxane degradation, which was true in the short term. In the long term, however, the cultures that received more THF were able to create more biomass (with the associated degradative enzymes) and ultimately degrade more dioxane than those cultures that received less THF (Figure 6). This is in accordance with our previous results that demonstrated that strain ENV478 which degrades THF in preference to 1,4-dioxane is able to degrade 1,4-dioxane at low levels for extended periods after growth on THF (Vainberg et al., 2006).

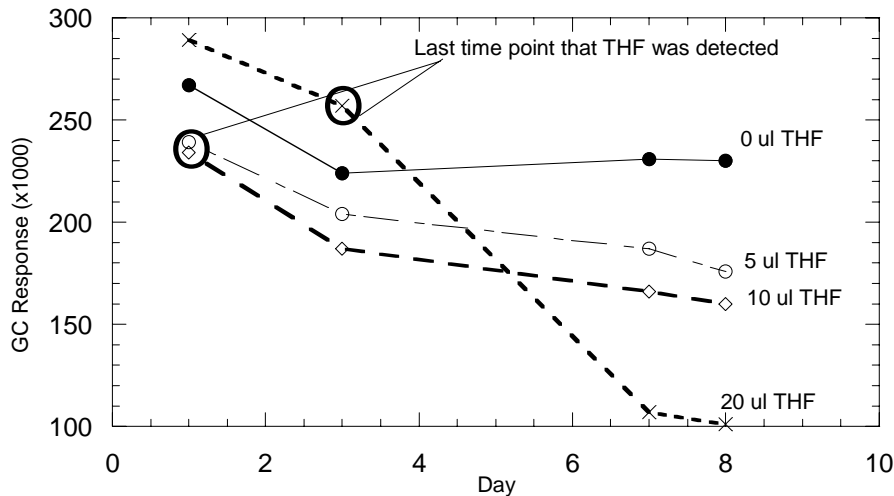

Figure 6. Degradation of 1,4-dioxane in the presence of different quantities of the co-substrate THF. This figure shows that THF inhibits the degradation of 1,4-dioxane (20 μ l/100 ml culture) in the short term but positively impacts the total amount of dioxane degraded in the long term.

A quaternary enrichment was performed to further enrich 1,4-dioxane degraders. Quaternary enrichments were comprised of 10 ml of the tertiary enrichment added to 90 ml of BSM in 250 ml flasks. All of the flasks received 20 μ l of 1,4-dioxane and 0, 5, 10, or 20 μ l of THF. Growth occurred only in the flasks that received THF. GC analysis indicated that THF was still preferentially degraded by the enrichment cultures, meaning

that 1,4-dioxane degradation would not occur until the THF concentration had been significantly reduced. It was possible to achieve 100% degradation of the 1,4-dioxane by making additional additions of THF, but there was no growth evident in the presence of 1,4-dioxane alone. 5-ml aliquots from each flask were pooled, mixed thoroughly, and re-added to fresh 250 ml flasks containing 95 ml of fresh BSM to create the next enrichment. This process was repeated an additional 5 times. This enrichment/selection regime was selected because bacteria have higher mutation rates when under starvation conditions, which drives evolution under proper selective conditions. Pooling the cultures that had experienced different lengths of starvation maximized the chance of isolating organisms that had acquired the ability to grow on the excess 1,4-dioxane. The flasks were inspected visually to determine if there was any growth on 1,4-dioxane alone. Visual inspection showed that growth was dependent on the presence of THF.

After the final enrichment, the pooled culture was divided into 5 flasks that received 1) No amendments; 2). 20 µl dioxane; 3) 20 µl THF; 4) 20 µl THF and 10 µl dioxane; and 5) 20 µl THF and 20 µl dioxane. The entire contents of the flasks were analyzed for total suspended solids (TSS; a measure of biomass) to quantitatively determine if dioxane was contributing to the growth of the cells. The results are shown below (Table 4).

Table 4. Increase in the Total Suspended Solids following growth on THF and/or 1,4-dioxane.

Additions	TSS after 10 days incubation (mg/100ml)
Inoculum only	14.52
Inoculum + 20 µl dioxane	17.24
Inoculum + 20 µl THF	87.19
Inoculum + 20µl THF + 10 µl dioxane	100.7
Inoculum + 20µl THF + 20 µl dioxane	118.79

There was a slight increase in the TSS of the flask that received only dioxane compared to the flask that received only inoculum. The minor change in TSS over the period of 10 days was considered to be insignificant. It was likely due to uneven distribution of cells during pipetting because the cells formed cohesive clumps that, although broken up by placing a sterile stir bar in flasks and mixing vigorously during pipetting were difficult to pipet. It was of interest to note that the TSS of the cultures was greater when 1,4-dioxane was present than when THF was added alone, suggesting 1,4-dioxane is being fully metabolized and contributing to the growth of the culture. THF, however, was still needed to initiate and sustain 1,4-dioxane degradation.

We also tried to work backwards, first enriching for a population that could degrade linear ethers (2HEAA and related ethers) and then trying to isolate individual colonies that could also initiate the degradation of 1,4-dioxane. To do this we set up an initial enrichment using 10 grams of water saturated carbon in 500 ml of BSM amended with 50 ppm diglycolic acid, 50 ppm diethylene glycol, 50 ppm polyethylene glycol, and 5 ppm 2HEAA. 5 ml of the primary enrichment was transferred to 95 ml of BSM and the same mixture of linear ethers for the secondary, tertiary and quaternary enrichments. After a quaternary enrichment was grown up, a dilution of the culture was plated on BSM media

solidified with noble agar (2% w/v). The plates were then grown in bell jars with 1,4-dioxane, THF, and toluene supplied in the vapor phase, and with no external carbon source as a negative control. Individual colonies were capable of growing on just the BSM agar but the colonies were relatively small in size. Similar growth was seen on the 1,4-dioxane and THF plates. Much more robust growth was seen on the toluene plates. Multiple colonies were simultaneously transferred to a single flask and provided with toluene as a growth substrate. The cells were subsequently harvested and checked for 1,4-dioxane degradation, which yielded a negative result.

We also used radio labeled 1,4-dioxane to determine the fate of 1,4-dioxane that was metabolized by pure cultures of THF degrading isolates and mixed cultures derived from THF enrichments and linear ether enrichments. Briefly stated, a pure culture of two separate unidentified THF degrading isolates produced 2HEAA as a dead end product, as determined by HPLC and CO₂ trapping. The mixed culture further metabolized the 2HEAA to 62% CO₂, 21% cell associated products, and 17% aqueous products. However, as before, the initial oxidation of 1,4-dioxane was THF dependant.

In summary, we tried multiple approaches to isolate an organism from the Stringfellow site that could grow on 1,4-dioxane. We attempted to identify growth regimes that would favor reproduction of bacterial species that had, or had acquired, the genetic material or mutations that would permit utilization of 1,4-dioxane as a sole source of carbon and energy. We found that a mixed culture that was grown on THF could continue to degrade 1,4-dioxane after the THF had been depleted, and also convert radio-labeled 1,4-dioxane into biomass and CO₂. Unfortunately, these positive results did not translate into enrichment of a culture that was capable of sustained growth on 1,4-dioxane.

II. C. 5. SLAC Site. In another attempt to identify naturally occurring 1,4-dioxane degraders, and/or to observe 1,4-dioxane in natural samples, we received samples in March 2006 from an activated carbon system that is treating 1,4-dioxane contaminated groundwater at the Stanford Linear Accelerator (SLAC) site. Some evidence from the site suggested that 1,4-dioxane may be degraded in the GAC system. Likewise, decreases in 1,4-dioxane in the influent stream had suggested that a 1,4-dioxane degrading population may have emerged in the site aquifer. Samples received included a portion of the carbon in the GAC canister and influent and effluent water samples. These samples were used to create enrichment cultures to isolate organisms that can grow on 1,4-dioxane or THF. After more than 4 months of incubation, no growth was apparent in any of the enrichment cultures, and no decreases in THF or 1,4-dioxane concentrations were observed.

II. D. Summary of Environmental Analysis.

Biodegradation of 1,4-dioxane by naturally occurring bacteria was evaluated by performing microcosm studies with samples from two different aquifers, and by performing enrichment culturing with samples from these sites, and from two other sites. Microcosms were incubated under aerobic, nitrate reducing, iron reducing, sulfate reducing, and methanogenic conditions. Some microcosms received sodium lactate,

molasses, or vegetable oil to simulate anaerobic biostimulation of chlorinated solvent degradation. Likewise, some aerobic microcosms received propane or tetrahydrofuran, known co-substrates for 1,4-dioxane degradation, while others received *Pseudonocardia* sp. strain ENV478 or *Rhodococcus* sp. strain ENV425 to simulate *in situ* bioaugmentation. 1,4-dioxane was not degraded in any of the anaerobic microcosms during >400 days of incubation. Some 1,4-dioxane degradation was observed in microcosms from Elkton, MD that had been stimulated with propane. Degradation in these microcosms was not apparent until >100 days of incubation, and an additional spike of 1,4-dioxane was not fully degraded. 1,4-dioxane also was degraded in microcosms augmented with strain ENV478 or strain ENV425 plus propane. Several repeat additions of 1,4-dioxane were degraded by strain ENV478, but repeated additions were not well degraded in microcosms augmented with strain ENV425 plus propane. Unfortunately, the difficulty of growing ENV478, its requirement for THF for prolonged activity, and its tendency to form dense cell clumps would likely limit its utility as a biocatalyst for *in situ* treatment of 1,4-dioxane.

Like the microcosm study, few positive results were achieved with our enrichment culturing efforts. No 1,4-dioxane degrading microbes could be enriched from the Elkton or New York Site aquifer samples. Likewise, no 1,4-dioxane degraders were enriched from the SLAC site GAC system. Although preliminary enrichments with samples from the Stringfellow Site treatment system suggested growth on 1,4-dioxane, we ultimately were unable to enrich suitable 1,4-dioxane degrading cultures from these samples.

Results of our environmental analysis suggests that 1,4-dioxane still is not degraded in environmental samples. Results of our pathway analysis studies (see below) suggest that degradation of 1,4-dioxane results in the production of another ether-containing compound (2HEAA) that is not further degraded by the 1,4-dioxane bacteria studied here. In addition, studies with THF-degrading bacteria like ENV478 suggested that 1,4-dioxane may be a poor inducer of 1,4-dioxane degradation genes. Studies with strain CB1190 (Paralles et al., 1994) suggest that under certain conditions, such as prolonged exposure to 1,4-dioxane in the presence of THF, environmental conditions may lead to mutations that will allow the cells to grow on 1,4-dioxane. Therefore, our results suggest that biological treatment, in the absence of biostimulation with propane or THF, may still not be a suitable treatment alternative for 1,4-dioxane. Furthermore, the recalcitrance of 1,4-dioxane under both aerobic and anaerobic conditions suggests that natural biological attenuation is unlikely to be a significant sink for 1,4-dioxane in the environment, and that alternative treatment methods will be required to prevent the migration of 1,4-dioxane contamination in aquifers.

III. MOLECULAR AND BIOCHEMICAL ANALYSIS

III. A. Introduction

The goal of our molecular and biochemical analysis of 1,4-dioxane degrading bacteria was to better understand how bacteria degrade 1,4-dioxane, and to identify factors that may limit complete degradation of this pollutant. To date, only two bacterial strain CB1190 and B5 (Mahendra and Alvarez-Cohen, 2006), have been show to grow on 1,4-dioxane as a sole source of carbon and energy. These strains, however, grow slowly and with poor cell yield on 1,4-dioxane, so they are unlikely to be a suitable catalyst for 1,4-dioxane remediation. A better understanding of the molecular biology and biochemistry of 1,4-dioxane degradation may allow us to overcome the barriers to its degradation, or to make more educated attempts to enrich for and isolate better 1,4-dioxane degraders. In addition, by understanding the genes and enzymes involved in 1,4-dioxane degradation it may be feasible to develop molecular tools to detect and monitor biomarkers of 1,4-dioxane degradation in environmental samples to better assess the fate of 1,4-dioxane. Similarly, by identifying the products of bacterial 1,4-dioxane degradation it may be possible to identify recalcitrant daughter products that can serve as indicators of *in situ* 1,4-dioxane biodegradation.

Previous work performed here (Vainberg et al., 2006) and elsewhere (Mahendra and Alvarez-Cohen, 2006) has shown that pre-exposure to a number of dissimilar growth substrates including methane, propane, toluene, and tetrahydrofuran can induce degradative enzymes that are capable of transforming 1,4-dioxane to unknown products. Because broad substrate oxygenase enzymes from at least three different classes (soluble diiron containing monooxygenases [SDMO], P450 monooxygenases, and AlkB type membrane bound diiron containing monooxygenases [MBMO]) are known to be involved in the metabolism of the substrates mentioned above, any of these also could be involved in 1,4-dioxane degradation. Therefore, we focused on evaluating 1,4-dioxane degradation by several organisms that utilize these different monooxygenase enzymes during their normal metabolism, and attempted to confirm the role of the specific enzymes in 1,4-dioxane degradation

For this portion of the project we examined three bacterial isolates, one that grew on tetrahydrofuran (ENV478) and two that grew on propane (ENV421 and 425) to determine which class or classes of enzymes were contained within these bacteria and to classify which enzyme(s) produced by each was responsible for degrading 1,4-dioxane. Furthermore, we sought to elucidate the biodegradation pathways resulting from attack of 1,4-dioxane by these enzymes.

III. B. Methods

III. B. 1. Isolation and maintenance of organisms of interest. The isolation of the *Mycobacterium* sp. Strain ENV421, *Rhodococcus* sp. Strain ENV425, and *Pseudonocardia* sp. Strain ENV478 has been described elsewhere (Steffan et al. 1997, Vainberg et al. 2006). The 2-hydroxyethoxyacetic acid (2HEAA)-degrading bacterium *Xanthobacter* sp. Strain ENV481 was isolated from the soil of Superfund landfill site located in southern New Jersey by providing microcosms with *bis*-(2-chloroethyl) ether as a sole source of carbon and energy. Multiple passes of the culture were made prior plating on R2A media. Individual colonies were screened for their ability to grow on BCEE, and a single pure culture was selected for further study and designated strain ENV481. Similar techniques were used to isolate *Ralstonia* sp. strain ENV482 that grows on diglycolic acid and 2HEAA as well uncharacterized polyethylene glycol degrading organisms that originated from suburban soil samples or mixed cultures obtained during other research performed at Shaw. All other organisms mentioned in this report were obtained from culture collections or directly from the research labs that isolated them. All of the environmental isolates were routinely maintained on R2A agar or Tryptic Soy Agar and grown in Basal Salts Medium amended with an appropriate carbon source, as indicated. All of the *E. coli* strains were grown and maintained LB broth or LB agar plates amended with the appropriate antibiotic, unless otherwise indicated. A list of the bacterial strains used in this study is shown in Table 5.

Table 5. Strains and plasmids used in this study.

Strain designation	Characteristic or use	Source
<i>E. coli</i> DH10B	General cloning	Invitrogen Inc.
<i>E. coli</i> BL21(DE3)	Protein expression	Promega Inc.
<i>E. coli</i> Solopack	PCR cloning	Stratagene Inc.
<i>E. coli</i> S17- λ -pir	Plasmid mobilization	Miller & Mekalanos, 1988
<i>Mycobacterium</i> sp. ENV421	Dioxane degradation	Steffan et al., 1997
<i>Rhodococcus</i> sp. ENV425	Dioxane degradation	Steffan et al., 1997
<i>Pseudonocardia</i> sp. ENV478	Dioxane degradation	Vainberg et al., 2006
<i>Xanthobacter</i> sp. ENV481	2HEAA degradation	Appendix 3
<i>Ralstonia</i> sp. ENV482	2HEAA degradation	This study
<i>M. smegmatis</i> MC2 155	Propane growth, transformable	Kaneda et al., 1988
<i>Bacillus cereus</i> (14737)	Superoxide dismutase	ATCC
<i>Pseudomonas putida</i> PPO200	Cloning and expression	Kukor et al., 1989
<i>Pseudomonas mendocina</i> KR1	Dioxane degradation	Yen and Karl, 1991
<i>P. putida</i> GPo12-pGEc47 Δ B	<i>alkB</i> expression	Smits et al., 2001
Plasmids		
pET3a	Protein expression	Promega Inc.
pNM185	Protein expression	Mermod et al., 1986
pSC-A	PCR cloning	Stratagene Inc.
pGEM-3Z	General cloning	Promega Inc.
pNV18	Cloning	Chiba et al., 2007
pCom8	Protein expression	Smits et al., 2001
pGS-704	Suicide plasmid	de Lorenzo et al., 1990

Selected cell lines were prepared for whole cell assays by growing the cultures under conditions where the cells would produce the enzymes that oxidize 1,4-dioxane and 2HEAA. The cells were harvested via centrifugation, rinsed with fresh media, and re-suspended to an OD₅₅₀ of 1-2. Aliquots of the prepared cells were then transferred to serum vials, typically 10 ml aliquots were placed in 60 ml serum vials, which were sealed with Teflon lined septa and the substrates were injected through the septa, typically to a final concentration 10-50 ppm.

III. B. 2. Chemicals. 1,4-dioxane (98%) was purchased from Aldrich Chemical Co. (Milwaukee, WI). R2A medium was obtained from BBL, Inc. (Cockeysville, MD). Unless indicated otherwise, all other chemicals were the highest purity available and were purchased from either Aldrich Chemical Co. (Milwaukee, WI), Mallinckrodt Specialty Chemical Co. (Paris, KY), J. T. Baker Inc. (Phillipsburg, NJ), or Sigma Chemical Co. (St. Louis, MO) unless otherwise indicated. Uniformly labeled 1,4-[¹⁴C]dioxane (0.08 mCi/mmol; 96.4% radiochemical purity as determined by high-performance liquid chromatography [HPLC]) was purchased from Sigma (St. Louis, MO). 2HEAA was synthesized in house. This synthesis involved preparation of sodium glycoxide by reacting excess ethylene glycol with metallic sodium. The glycoxide was then reacted with chloroacetic acid to obtain the sodium salt of 2HEAA (NaHEAA). [¹⁴C]-2HEAA was made by transforming [¹⁴C]-dioxane using THF grown ENV478 as a catalyst for the reaction, which was monitored via GC analysis. Once the transformation was complete the cells were removed via centrifugation and filtration to sterilize the 2HEAA containing media.

II. B. 3. Analytical Methods.

III. B. 3a. Analytic techniques for monitoring the degradation of 1,4-dioxane and its metabolites. The disappearance of THF and 1,4-dioxane was monitored by injecting 1 µl of liquid sample into a Varian 3400 gas chromatograph (Varian, Walnut Creek, Calif.) equipped with a 30-m capillary Vocol column (Supelco, Inc., Bellefonte, Pa.) and a flame ionization detector. The injector and detector temperatures were maintained at 180 and 220°C, respectively, whereas the column temperature was programmed to increase from 85°C to 140°C at a rate of 50°C/min. The presence and disappearance of dioxane, 2HEAA, and other potential metabolites thereof, was monitored by HPLC and IC analysis. To prepare the samples for analysis, 500 µl of sample was placed in a microcentrifuge tube and centrifuged for 5 min at 14,000 rpm (16,000 × g) to remove the cellular material. The supernatant was then transferred to a 1-ml autosampler vial, which was sealed with a Teflon septum. The metabolites were resolved with a Restek Ultra Aqueous C₁₈ column (3.2 by 150 mm; Restek, Bellefonte, PA) and an isocratic mixture of methanol and water (5:95) at a flow rate of 0.4 ml/min. Elution of dioxane and its metabolites from the column was monitored at a wavelength of 210 nm. The HPLC eluant was divided into fractions (5- to 30-s intervals) by collecting the eluant in scintillation vials prefilled with 3 ml of scintillation cocktail so that the amount of radioactivity in each fraction and the total radioactivity in the supernatant could be determined. Alternately, the elution of [¹⁴C] dioxane and metabolites was monitored using a β-RAM 2B flow through scintillation counter (IN/US Systems Inc.).

The elution order of the metabolites was determined by spiking authentic standards with radiolabeled products. Ion chromatography was used to identify volatile fatty acids that were produced during the metabolism of dioxane and 2HEAA using a Dionex AS50 IC system (Dionex Inc., Sunnyvale CA) and USEPA method 9056A.

Analyzing the fate of ^{14}C -dioxane that had been transformed to unknown products partitioned between CO_2 , cell associated material, and the supernatant was performed by trapping the CO_2 in a base traps and separating the cells and the supernatant via centrifugation prior to adding sub-samples of the three fractions to scintillation cocktail for scintillation counting.

III. B. 3b. DNA and RNA Techniques Genomic DNA was isolated from bacterial cells using the UltraClean™ Microbial DNA Isolation Kit (Mo Bio Laboratories, Inc. CA) following the directions of the manufacturer. Plasmids were isolated with the NucleoSpin plasmid Miniprep kit (BD Biosciences, CA) or with Qiaspin columns (Qiagen Inc., Valencia, CA). Total RNA from the bacterial cells was isolated with an RNeasy Mini kit (Qiagen, Valencia, CA) with some modifications. The harvested cells were treated with lysozyme at 37°C for 20 min and cell debris was removed by centrifugation for 10 min. The supernatant was treated with Trizol and chloroform, and then washed by propanol. RNA was further cleaned up with DNaseI and further purified with the RNeasy Mini kit.

III. B. 3c. Standard PCR Normal PCR amplification was performed using GoTaq Green Master Mix (Promega Inc., Madison, WI) or Fusion High Fidelity polymerase (Stratagene Inc., La Jolla, CA) following the manufactures guidelines with altered annealing temperatures and extension times as dictated by the DNA sequence being amplified. A list of the PCR primers used in this study is presented in Appendix 2.

III. B. 3d. DNA hybridization Southern hybridization was carried out following standard procedures. Briefly, 200 ng of genomic DNA was digested with various restriction enzymes and separated on 1% agarose gel. DNA was transferred to a nylon membrane and Southern hybridization performed as recommended by the supplier for the DIG non-radioactive nucleic acid labeling and detection system (Boehringer Mannheim, Germany).

III. B. 3e. Quantitative reverse transcriptase PCR Real time quantitative reverse transcriptase PCR (QRT-PCR) was carried out with a 7300 Real-Time PCR System (Applied Biosystems, USA) following the manufacturer's protocol.

III. B. 3f. 16S rRNA analysis. Total genomic DNA was isolated from the strains analyzed by using a DNA extraction kit (Clontech, Mountain View, CA). The 16S rRNA genes were PCR amplified with primers 27f and 1522r under conditions recommended by the supplier (Sigma, St. Louis, MO). The purified PCR product (QIAGEN, Valencia, CA) was used directly in DNA sequencing reactions (Applied Biosystems, Foster City, CA) with primers 27f, 357f, 704f, 926f, 1242f, 342r, 685r, 907r, 1392r, and 1522r (Johnson et al., 2004). The complete sequence was assembled and

edited with the Lasergene program (DNASTar, Madison, WI). Closely matching sequences were found in the GenBank database using the BLAST algorithm (Altschul et al., 1997), as well as the search function of the Ribosomal Database Project (Cole et al., 2005). Sequences were aligned using CLUSTALV in the Lasergene software package (DNASTar) and were visually inspected. Phylogenetic analysis was performed with the MEGA version 2.1 software package (Kumar et al., 2001). Distances were determined by maximum parsimony, and bootstrap values were calculated by using 1,000 replications.

III. B. 3g. DNA Sequence analysis. Nucleotide sequences were determined with an ABI PRISM 3100 Genetic Analyzer (Applied Biosystems, USA). The sequence was compared with existing sequences in the GenBank database by performing a BLAST search (Altschul, 1997). Multiple alignments of homologous sequences were generated by a Clustal W alignment using the Lasergene software (DNASTAR, inc., USA). Pair wise sequence comparisons were performed using Blast2 (Tatusova et al. 1999).

III. B. 3h. 5' RACE assay. The transcription start sites upstream of *orfY*, *thmS*, and *thmB*, were determined by a 5' RACE assay (Invitrogen, USA) following the manufacturer's instructions. RNA extracted from THF-grown cells was used for this study.

III. B. 3i. Gene Cloning. Cloning of PCR fragments was typically accomplished using the StrataClone™ PCR Cloning Kit (Stratagene Inc., La Jolla, CA) and the pSC-A vector which uses DNA topoisomerase I and Cre recombinase to incorporate PCR fragments into the cloning vector. Subsequent cloning steps involved the traditional digestion of the DNA with restriction endonucleases, purification of the desired DNA fragment, followed by ligation to the plasmid vectors as indicated.

III. B. 3j. Transformation of competent cells. Competent cells used in electroporation protocols were made by growing the cells until mid-exponential phase in a suitable media before harvesting, rinsing, and concentrating the cells in a 10% glycerol solution. Introduction of DNA was accomplished using a BioRad gene pulser set at 25µF, 200 Ω and 1.25 kV. *E. coli* cells were made competent by growing them to mid log phase in LB broth and preparing them for transformation by rinsing them once in 100 mM calcium chloride₂ and resuspending them in 1/10th the original volume of 100 mM CaCl₂, prior to transforming the DNA into the with a heat pulse at 42° C.

III. B. 3k. Protein purification and protein sequencing. Cytoplasmic and membrane proteins were purified from cells grown on substrates that induced the genes of interest and a non inducing substrate such as succinate with the Proteoprep kit (Sigma Inc., St. Louis, MO) following the manufacturer's instructions. The purified proteins were separated on an SDS-PAGE gel. SDS-PAGE gel was composed of 7% acrylamide, Stacking gel 4x buffer (0.5M Tris pH 6.8) or resolving gel 4x buffer (1.5M Tris pH6.8), 0/1% SDS, 0.05% ammonium persulfate, and 0.067% TEMED. Samples were loaded with Laemmli loading buffer (80mM Tris-Cl pH 6.8, 2% SDS, 10% Glycerol, 5.3% B-mercaptoethanol, and 0.02% Bromophenol blue). Gels were run in a 1x PAGE running buffer (25mM Tris-Base, 0.25M glycine, and 0.1% SDS, pH8.3) at 25 mA for 5 hours.

Colloidal Coomassie Staining for visualizing proteins was done with a solution of 1.6% ortho-phosphoric acid, 8% ammonium sulfate, 0.08% CBB G250, 20% methanol, and later destained with distilled water.

For protein sequencing, unstained proteins on the PAGE gel were electroblotted onto a PDVF membrane using a transfer buffer (25 mM Tris-base, 192 mM Glycine, 20% methanol) chilled to 4°C. The gel was equilibrated in the transfer buffer for 15 min and then soaked in methanol, water, and then in transfer buffer for 2 min each. The proteins of interest were blotted on to the membrane over night at 25 V. The membrane was then stained with amido black (0.1% amido black and 10% glacial acetic acid) for 1 hour and destained with 5% acetic acid to reduce the background stain. Propane-induced protein bands were cut out from the membrane and then subjected to N-terminal sequencing by the protein sequencing facility at Iowa State University.

Alternately, protein identification work was carried out at ProtTech, Inc (Norristown, PA) by using the NanoLC-MS/MS peptide sequencing technology. In brief, protein bands of interest excised from SDS-PAGE gels were destained, cleaned, and digested in-gel with sequencing grade modified trypsin. The resulted peptides mixture was analyzed by a LC-MS/MS system, in which a high pressure liquid chromatography (HPLC) with a 75 micrometer inner diameter reverse phase C18 column was on-line coupled with an ion trap mass spectrometer. The mass spectrometric data acquired were used to search the most recent non-redundant protein database with ProtTech's proprietary software suite. The output from the database search was manually validated before reporting.

III. C. Molecular Analysis Results

III. C. 1. Strain ENV478. Enrichment culturing of an industrial waste-water treatment system allowed the isolation of several bacterial isolates that could grow on THF as a sole carbon and energy source. No organisms, however, were able to grow on 1,4-dioxane. One isolate was selected for further studies, and designated strain ENV478. Analysis of the 16s rDNA sequences of the strain indicated that it is a member of the *Pseudonocardia* genus and clusters with the sequences for the *benzenivorans* (Kampfer and Kroppenstedt, 2004), *dioxanivorans*, *hydrocarbonoxydans*, and *sulfidoxydans* species (Figure 7).

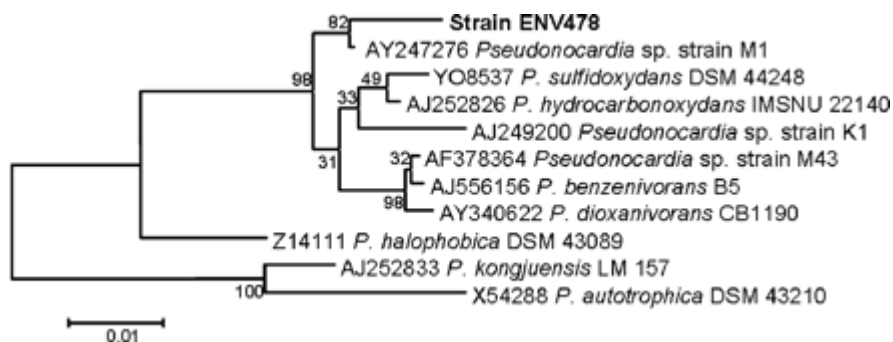

Figure 7. Dendrogram showing the phylogenetic relationship of strain ENV478 to closely related *Pseudonocardia* strains. The GenBank accession number, genus, species (if known), and strain designation are indicated for each 16S rRNA sequence. The bootstrap values at the nodes indicate the percentages of occurrence in 1,000 bootstrapped trees. Bar, genetic distance of 0.01.

The ability to degrade THF is well known within this cluster, with strains M1, K1, and CB1190 all having this characteristic (Daye et al., 2003; Kohlweyer et al., 2000, Mahendra et al., 2005). Given the 16S rRNA sequence distances between the *benzenivorans*, *dioxanivorans*, *hydrocarbonoxydans*, and *sulfidoxydans* species, and the sequence distance between strain ENV478 and these same species, strain ENV478 is likely a new member of the *Pseudonocardia* species.

When grown on BSM with THF the culture produced dense clumps of cells that made accurate sampling and optical density measurements difficult. The culture grew readily on BSM with yeast extract, and on R2A agar plates. It also grew on lactate, propane and sucrose, and on the following compounds at 200 mg/L each: 1-propanol, 2-propanol, 1-butanol, diethyl ether, diisopropyl ether, propionic acid, butanoic acid, pentanoic acid, and hexanoic acid. It grew on 50 mg/L octanoic acid, but not at 100 or 200 mg/L. It did not grow on octanol or hexanol, and growth on 1,4-dioxane and 1,3-dioxolane was slight or absent after 30 days of incubation.

III. C. 2. Biodegradation of 1,4-dioxane. Following growth on THF, strain ENV478 degraded 1,4-dioxane at an initial rate of approximately 21 mg/h x g TSS, which was approximately one third of the rate at which it degraded THF (63 mg/h x g TSS). When the two substrates were added together at equal concentrations, 1,4-dioxane degradation did not proceed until the THF was removed from the medium (Figure 8). When similarly grown cells were incubated with both 1,4-dioxane and 1,3-dioxolane they degraded both compounds simultaneously and at approximately the same rate (data not shown).

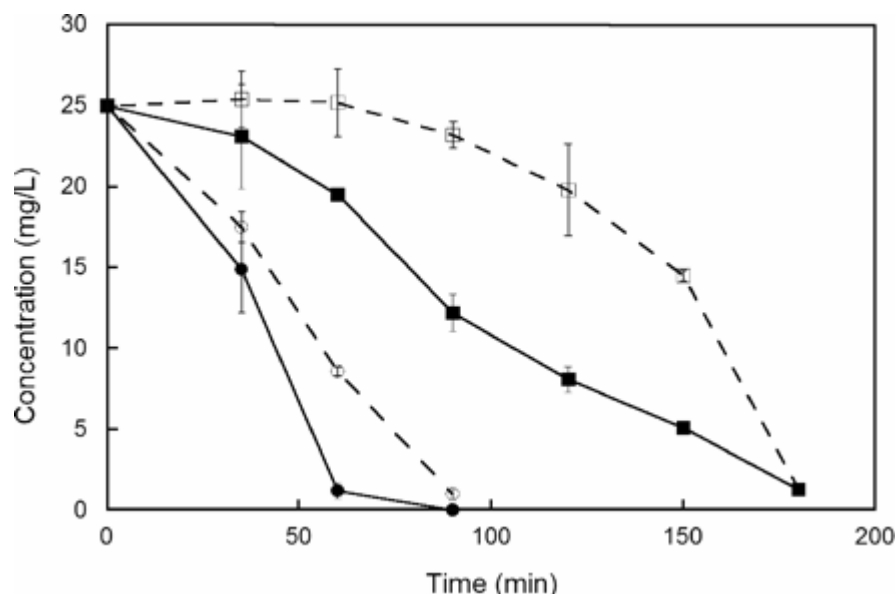

Figure 8. Simultaneous biodegradation of 1,4-dioxane (squares) and THF (circles) by strain ENV478 when the compounds were added alone (solid symbols) or as a 50:50 mixture (open symbols). The error bars indicate one standard error of the mean ($n = 3$).

Strain ENV478 also degraded 1,4-dioxane after growth on sucrose (0.71 mg/hr x g TSS), yeast extract (1.1 mg/hr x g TSS), sodium lactate (0.6 mg/hr x g TSS), 2-propanol (1.5 mg/hr x g TSS) and propane (3.2 mg/hr x g TSS) (Figure 2), but the 1,4-dioxane degradation rates were much lower than with THF-grown cells (63 mg/hr x g TSS). After growth on yeast extract, the strain degraded.

In other degradation experiments with THF-grown strain ENV478, the culture was able to degrade the related solvent 1,3-dioxolane (19 mg/hr x g TSS), the gasoline additive methyl *tert*-butyl ether (MTBE) (9.1 mg/hr x g TSS), and the plasticizer *bis*-2-chloroethyl ether (BCEE) (12 mg/hr x g TSS). Interestingly, the strain degraded 1,4-dioxane faster after growth on THF than after growth on propane, but it degraded BCEE about 3 times faster after growth on propane than after growth on THF (32 vs. 12 mg/hr x g TSS). Although the products of BCEE and 1,3-dioxolane degradation were not analyzed, MTBE oxidation resulted in the accumulation of *tert*-butyl alcohol (TBA) that was not further degraded by the strain.

In addition to strain ENV478, we evaluated 1,4-dioxane degradation by our previously described ether degrading propanotroph strain ENV425 (Steffan et al., 1997). Strain ENV425 also grew on THF and degraded 1,4-dioxane, but at only half the rate (10 mg/h x gTSS) of strain ENV478. Furthermore, whereas strain ENV478 degraded 1795 mg 1,4-dioxane/g TSS after stopping THF feeding, strain ENV425 degraded only 200 mg 1,4-dioxane/g TSS.

III. C. 3. 1,4-Dioxane degradation pathway analysis. We analyzed the 1,4-dioxane degradation products produced by THF-grown strain ENV478 (Vainberg et al.,

2006), THF-grown *Mycobacterium* sp. strain ENV421, propane-grown *Rhodococcus* sp. strain ENV425 (Steffan et al., 1997), cloned toluene 4-monooxygenase of *Pseudomonas mendocina* KR1 (Whited and Gibson, 1991; Yen et al., 1991) (expressed in *Pseudomonas putida* PPO200 [McClay et al., 1996]), and three other uncharacterized THF-grown pure cultures. The analytical procedures were established using the ENV478 isolate. After incubated with uniformly labeled [¹⁴C]1,4-dioxane, all of the strains produced [¹⁴C] 2HEAA as a sole product. Attempts to isolate chemically synthesized 2HEAA from aqueous solution after acidification of NaHEA were hampered by apparent conversion of 2HEAA to PDX in a pH driven equilibrium (Braun and Young, 1977). The equilibrium is driven towards PDX at low pH (pH 2 to 3), and demonstrated by the appearance of PDX in solutions of NaHEA after acidification. The equilibrium was difficult to monitor because of the inability to analyze for both PDX and 2HEAA in a single analysis without the potential for interconversion. Direct GC/MS analysis of PDX product solutions showed only PDX due to the inability to see 2HEAA without derivatizing it to a methyl ester. Analysis of PDX product solutions for 2HEAA by the methyl ester derivatization method showed the presence of both PDX and 2HEAA in a ratio of about 1:4 (PDX:2HEAA), but the methyl ester 2HEAA derivative may have been formed from PDX during the derivatization process. This made identification and determination of the PDX purity, and analysis of PDX in cultures, difficult because the derivatization method may lead to the identification of both compounds as 2HEAA. Consequently, we verified that the single peak identified as 2HEAA via HPLC was in fact 2HEAA by also analyzing the sample via ion chromatography (Dionex Co., Sunnyvale, CA) using the USEPA method 9056A. No other potential intermediates were detected at this point. The 2HEAA product was not degraded further, even after 402 h of incubation at 25°C. Addition of THF to cultures that had depleted the 1,4-dioxane and accumulated 2HEAA did not result in further degradation of this product. At the end of the experiment, no overall decrease in the radioactivity in the culture supernatant was observed compared to the radioactivity in the control, indicating that no carbon dioxide had been produced and no 1,4-dioxane was converted to biomass. In separate growth studies, strain ENV478 was not able to grow on 2HEAA as a sole carbon source. Results of the pathway analysis are presented in Figure 9, and they have been described in detail in a publication of this portion of this study (Vainberg et al., 2006; appendix 2).

To further evaluate the extent of degradation of 1,4-dioxane by strain ENV478, THF-grown cells were washed and incubated with uniformly-labeled [¹⁴C]1,4-dioxane, and an HPLC method that did not require derivatization was developed and employed. Analysis of the culture liquor demonstrated that the [¹⁴C] 1,4-dioxane was converted to a product that co-eluted with authentic 2HEAA. This product was not degraded further, even after 402 hours of incubation at 25 °C. The addition of THF to cultures that had depleted the 1,4-dioxane and accumulated 2HEAA did not result in further degradation of this product. At the end of the experiment, no overall decrease in radioactivity contained in the supernatant was observed relative to the control, indicating that no carbon dioxide had been produced and no 1,4-dioxane was converted to strain ENV478 biomass. In separate growth studies, strain ENV478 was not able to grow on 2HEAA as a sole carbon source.

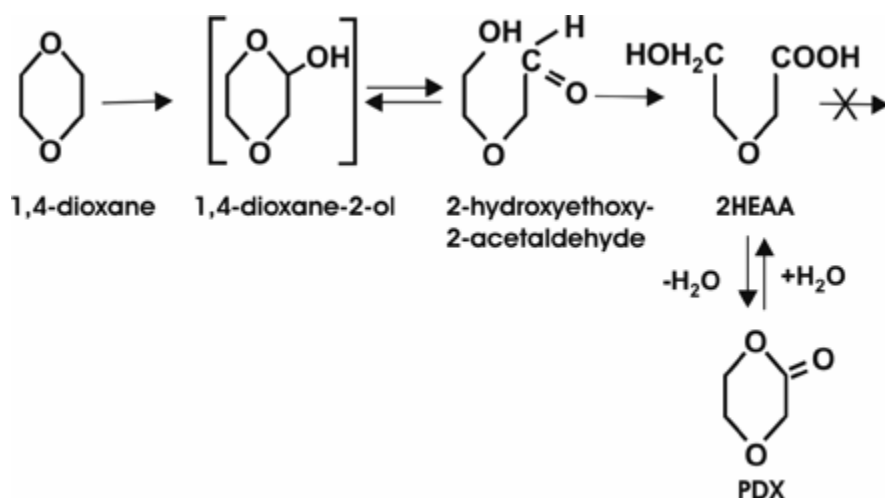

Figure 9. Proposed pathway for biodegradation of 1,4-dioxane by THF, toluene, and propane oxidizing organisms. The 1,4-dioxane-2-ol (hemiacetal) and 2-hydroxyethoxy-2-acetaldehyde were not detectable in the culture media by the methods used in this study. *Para*-dioxone (PDX) is expected to form spontaneously from 2HEAA under certain conditions, but it was not detectable in our experiments. Derived from Vainberg et al. (2006).

Similar 1,4-dioxane degradation experiments were performed with all of the other strains listed above with the same end result. In pure culture all of these isolates converted all of the added [^{14}C]1,4-dioxane to a single compound identified as 2HEAA by using HPLC and IC analysis, to the exclusion of any other detectable product (Figure 10). Extend incubation and addition of additional growth and inducing substrates did not result in further degradation of 2HEAA, indicating that it is the terminal product of 1,4-dioxane transformation by these strains under the conditions described.

III. C. 4. Molecular Analysis.

III. C. 4a. *Pseudonocardia* sp. strain ENV478

III. C. 4a1. PCR based probing for monooxygenase sub-groups.

Experiments were performed to detect and identify monooxygenase genes in strain ENV478. Probing of ENV478 chromosomal DNA with degenerate PCR primers designed to amplify monooxygenases belonging to the P450, soluble diiron, and membrane bound diiron sub-families (Appendix 1) revealed that ENV478 contained a soluble diiron monooxygenase, several P450 monooxygenases, but apparently no membrane bound diiron monooxygenases. Quantitative reverse transcriptase PCR experiments revealed that following growth on THF, a growth substrate that induces the expression of enzymes that degrade 1,4-dioxane, there was increased expression of enzymes belonging to the soluble diiron monooxygenase and P450 sub groups. Cloning and sequencing of these fragments showed that a single SDMO and two P450s were

being produced during growth on THF. The first P450 showed highest similarity to a cytochrome P450 from *Amycolatopsis mediterranei* (81% identical), and second P450 was most similar to one found in *Chromobacterium violaceum* strain 968 (97% identical). Both of the homologous P450 enzymes are thought to participate in polyketide synthesis. As such, they are not expected to be involved in THF or 1,4-dioxane oxidation.

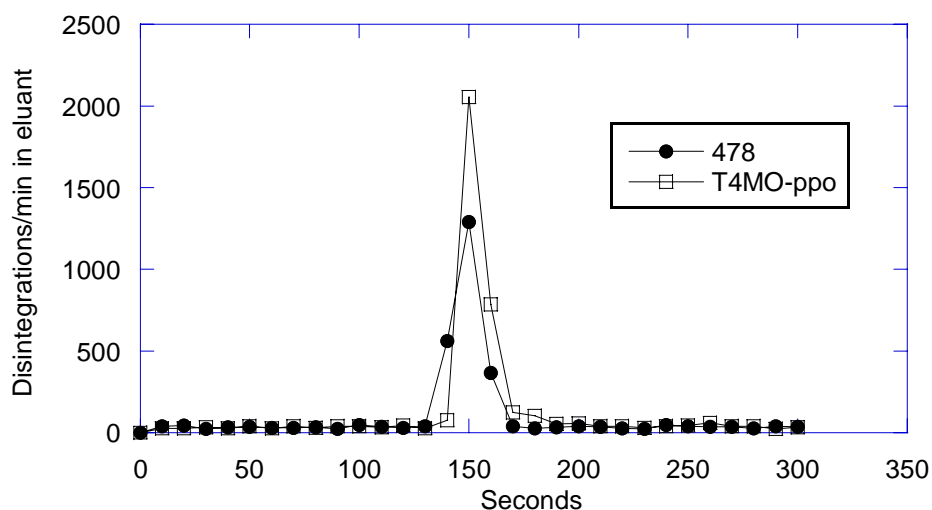

Figure 10. Elution profile of the metabolites resulting from transformation of [^{14}C] 1,4-dioxane by strain ENV478 and toluene-4-monoxygenase (expressed in *P. putida*). The analysis shows that 1,4-dioxane metabolism by the enzyme system of ENV478 and the T4MO of *Pseudomonas mendocina* KR1 result in the formation of the same end product; 2HEAA.

The SDMO fragment, however, was similar to the SDMO of *Pseudonocardia* sp. strain K1 (Theimer et al., 2003) which has been implicated as the enzyme responsible for THF degradation by this strain. A combination of PCR and inverse PCR (Ochman et al., 1988) allowed us to determine the DNA sequence of the approximately 10 kb region of DNA that comprises the THF monooxygenase gene cluster in ENV478 (Figure 11). The gene order of putative *thf* gene cluster in ENV478 is identical to the homologous gene cluster found in *Pseudonocardia* K1, with an overall DNA sequence identity of 93%. The proposed function of each gene in the cluster is shown in Table 6. The functions of the genes encoding the open reading frames *orfY*, *Q*, and *Z* have not yet been determined, but it is of note that homologues of *orfY* are found in operons that are responsible for the degradation of another ether, ethyl-*tert*-butyl-ether, whereas *orfZ* has a structure similar to membrane associated peptides and could be involved in signaling or transport. Transcriptional analysis showed that while there are two separate transcriptional units in the *thf* operon (Figure 11), they are both up-regulated in the presence of THF, as determined by QRT-PCR (Figure 12).

Based on the molecular analysis and the evidence obtained during the evaluation of the initial products of 1,4-dioxane degradation by ENV478 we hypothesized that the *thf* operon was active in the degradation of 1,4-dioxane by this strain.

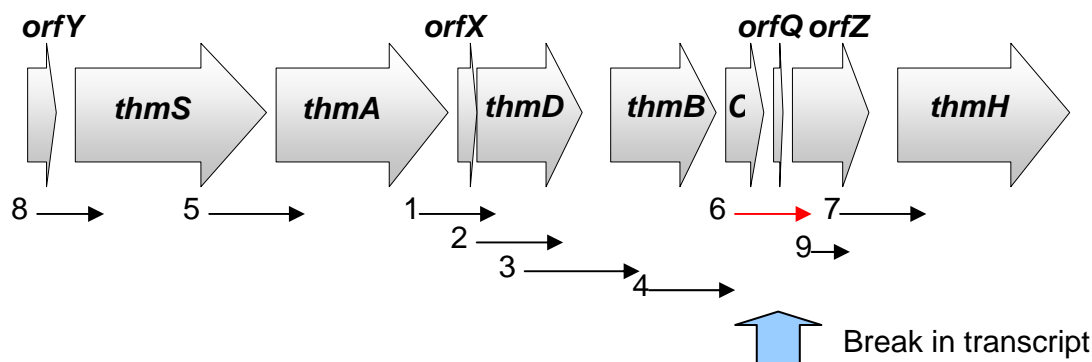

Figure 11. Analysis of the transcriptional organization of the *thf* operon of strain ENV478. RT-PCR experiments using primers that amplify two neighboring genes showed that *ORFY*, *thmS*, *A*, *D*, *B* and *thmC* were co-transcribed. This transcript did not include the downstream genes, *orfZ* and *thmH* which themselves form another operon.

Table 6. Proposed functions of genes in the *thf* operon of strain ENV478.

Gene	Proposed function
<i>orfY</i>	Unknown
<i>thmS</i>	Succinate semi-aldehyde dehydrogenase
<i>thmA</i>	Monooxygenase α -subunit
<i>thmD</i>	NADH oxidoreductase
<i>thmB</i>	Monooxygenase β -subunit
<i>thmC</i>	Coupling protein
<i>orfQ</i>	Unknown
<i>orfZ</i>	Unknown (membrane associated)
<i>thmH</i>	4-Hydroxybutyraldehyde dehydrogenase

III. C. 4a2. Cloning and expression of the *thf* operon of ENV478. We attempted to verify the role of the *thf* operon in the degradation of 1,4-dioxane in strain ENV478 by cloning the monooxygenase associated genes (*thfADBC*) and expressing them in heterologous hosts. Our first attempt was the straight forward PCR amplification of the genes directly from the strain ENV478 chromosome, without any modification, and cloning them in the pGemZ3 vector in *E.coli*. Individual clones were assayed for THF and 1,4-dioxane degradation, but none of the clones could oxidize these substrates.

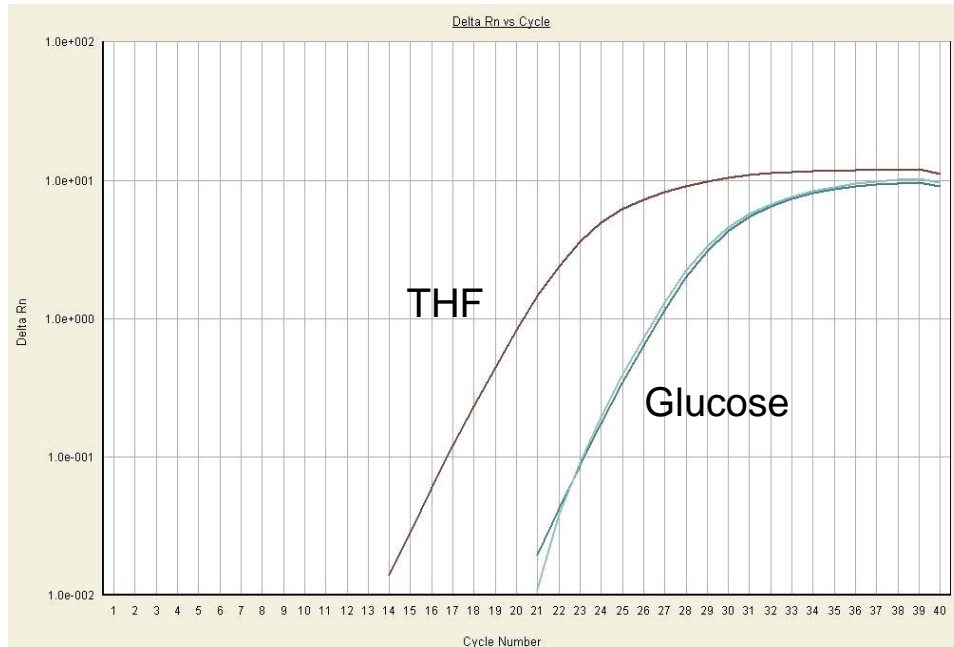

Figure 12. Quantitative RT-PCR analysis of expressions indicated that both of these operons are up-regulated (~32-fold) in the presence of THF.

III. C. 4a3. Creating a synthetic *thf* operon. During our analysis of the *thf* operon gene sequences we had noted that some of the genes had overlapping reading frames, and they used the “gtg” start codon which is poorly recognized in *E. coli*. Furthermore, in some instances the spacing between the ribosomal binding sites and their start codons were atypical for genes that are strongly expressed in *E. coli*. This unusual DNA sequence configuration may have hindered the expression of the cloned genes in the *E. coli* host. To address this concern we designed PCR primers that created an *Nde* I site that overlapped the start codon of the *thfA* gene and also created an *Nhe* I site following the stop codon of the gene. This fragment was then cloned into the protein expression vector pET3A so that the cloned genes were down stream of a strong *E. coli* ribosomal binding site sequence. The same procedure was followed for the *thfD* gene. The plasmid containing the *thfD* gene was then digested with the enzymes *Xba* I/*Nhe* I, releasing the *thfD* gene fused to the strong, optimally spaced ribosomal binding site that is found in pET3A. The *Xba* I/*Nhe* I fragment was then ligated to the expression plasmid containing the *thfA* that had been digested only with *Nhe* I. Fusing the *Nhe* I site located at the 3’ end of the *thfA* gene to the *Xba* I site at the 5’ end of the *thfD* gene destroys both restriction sites but leaves the *Nhe* I/*Nhe* I junction at the 3’ end of the *thfD* gene if the incoming gene is properly oriented. This process was repeated for each gene, thereby reassembling the four genes into an artificial operon that had optimal spacing between the preferred start codon of each gene and the strong T7 ribosomal binding site acquired from pET3A plasmid. The resulting plasmid was transformed into *E. coli* BL21(DE3) for expression experiments and activity assays. SDS-PAGE analysis showed that *thfA*, *B*, and *D* were expressed in the clones, but it could not be determined definitively that *thfC* was being produced (Figure 13). The *thfC* gene product is rather small, so it is difficult

to visualize on protein gels. Because the other genes were easily detected, however, it was assumed the *thfC* was also being expressed.

To evaluate functional activity of the cloned synthetic operon, clones were incubated with either THF or 1,4-dioxane. Unfortunately, there was no discernable degradation of either substrate using these clones. The reason for the lack of activity is not clear, but it was of note that the proteins responsible for the degradation of THF in *Pseudonocardia* sp strain K1 lost activity very rapidly (Theimer et al., 2001), preventing them from being used in cell free assay. This suggests that the enzyme is highly unstable, a property that might make heterologous expression difficult or impossible.

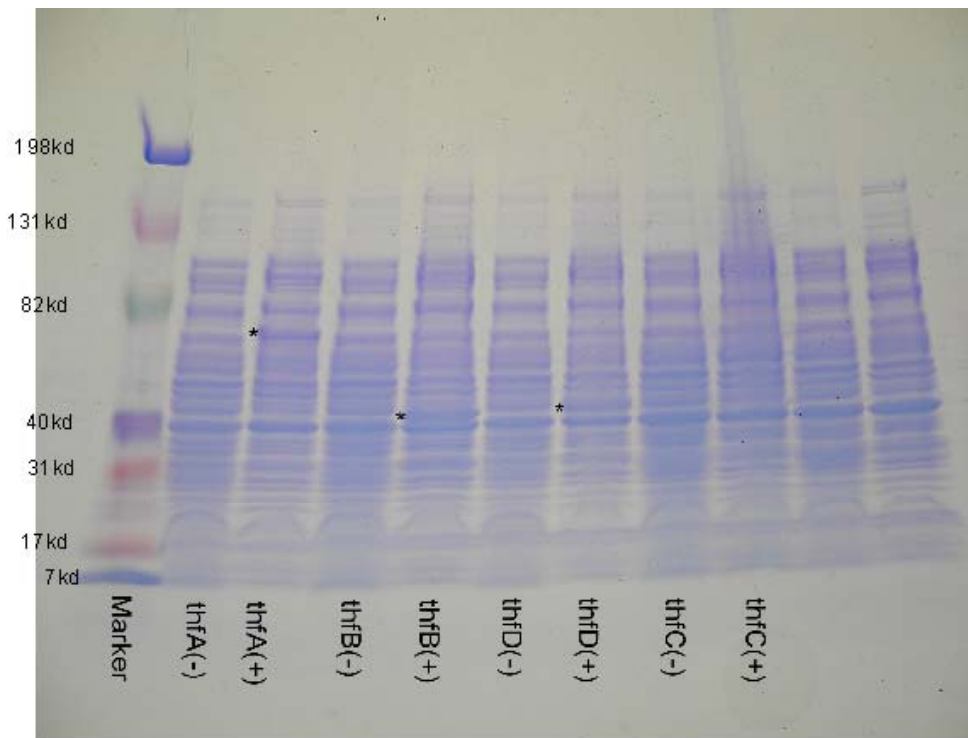

Figure 13. SDS-PAGE analysis of the individual *thf* operon peptides. Individually cloned genes were expressed in pET3A by the addition of IPTG (“+”). Location of the cloned peptides are indicated by “*”. Predicted molecular weights of the peptides are as follows: *thfA*, 64 kDa; *thfB*, 39 kDa; *thfD*, 40 kDa; *thfC*, 12 kDa.

III. C. 4a4. Alternative approaches. Several alternative approaches were tested to prove that the *thf* genes were involved in the degradation of 1,4-dioxane. The first alternate technique involved the disruption of the *thf* operon with a gene encoding for kanamycin resistance. For this, the kanamycin resistance gene found in the *Nocardia* shuttle vector pNV18 was amplified and inserted in the middle of the *thmADBC* gene cluster. This fragment was cloned into the pGEM-3 vector, which does not replicate in ENV478 (Figure 14). The modified plasmid was inserted into strain ENV478 by using electroporation, but no kanamycin resistant colonies were found. This suggested that either the electroporation procedure was inefficient with this strain, the cloned kanamycin resistance gene was not expressed in strain ENV478, or that more time was needed to allow homologous recombination between the interrupted genes and the native *thf* operon. For this reason the *thmADBC::Km* fragment was cloned into the pNV18 plasmid, a plasmid that does replicate in ENV478. The resulting plasmid was electroporated into ENV478 resulting in the isolation of kanamycin resistant colonies. It was found that without a selection pressure, the plasmid is lost in approximately 50% of the colonies. Accordingly, we screened for colonies that had lost the plasmid but retained the kanamycin resistance gene. We were not able to isolate a colony with the desired phenotypic or genotypes. Concurrent with the writing of this report, we are still in the process of searching for colonies that have lost the plasmid and the wild type *thf* operon but have retained the kanamycin gene inserted in the *thmB* gene.

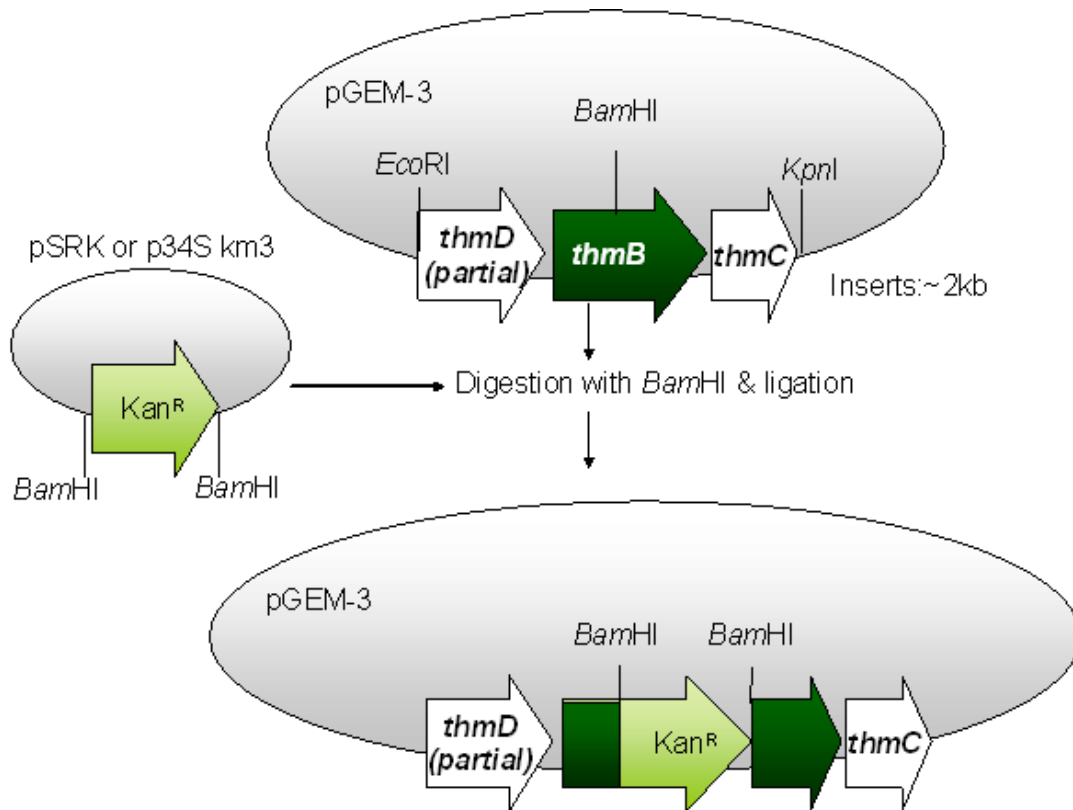

Figure 14. Schematic of the non-replicative plasmid constructed for inactivating the *thmB* gene of ENV478.

Finally, the *thmA**DBC* genes and ORF-Z operon has been cloned into the *Mycobacterium* shuttle vector, pJAM-2, under the control of the *lacZ* promoter located in the plasmid. The construct was electroporated into *Mycobacterium smegmatis*, but no dioxane degrading activity was observed.

III. C. 4b. *Rhodococcus* sp. Strain ENV425.

III. C. 4b1. PCR based probing for monooxygenase sub-groups. Strain ENV425 degrades 1,4-dioxane after growth on propane (Vainberg et al., 2006). Therefore, molecular analysis also was performed to identify genes involved in 1,4-dioxane degradation by this strain. PCR probing of strain ENV425 chromosomal DNA revealed that representatives of all three oxygenase sub-families are contained in ENV425, however, RT-PCR showed that only the SDMO was induced following growth on propane in this organism (Figure 15).

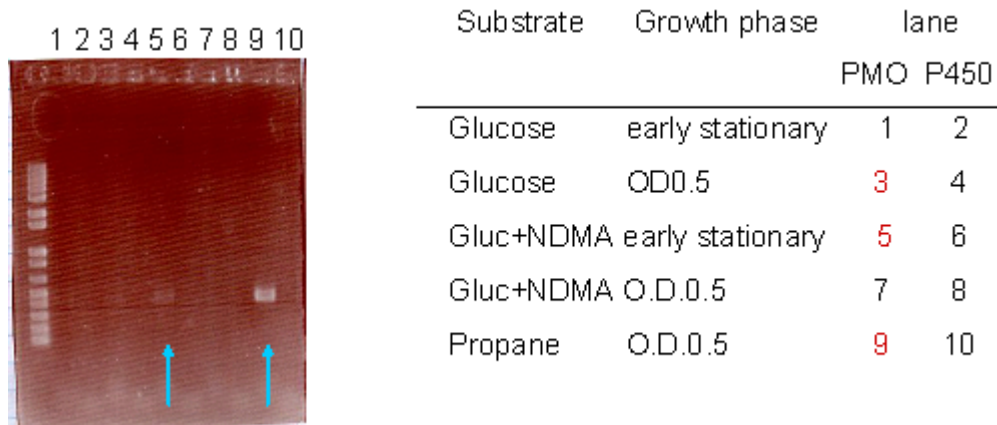

Figure 15. RT-PCR showing the differential expression of the PMO of strain ENV425 in response to different growth substrates or amendments. P450 genes identified in the strain were not expressed under the growth conditions used in this experiment.

Cloning and DNA sequence analysis of the fragment expressed by strain ENV425 following growth on propane identified the gene as a homologue of the proven propane monooxygenase found in *Gordonia* sp. Strain TY-5 (Kotani et al., 2003) and its putative homologues in *Rhodococcus* sp. Strain RHA1 (McLeod et al., 2006) and *Mycobacterium smegmatis* MC2 155 (Genbank number CP000480) (Figure 16).

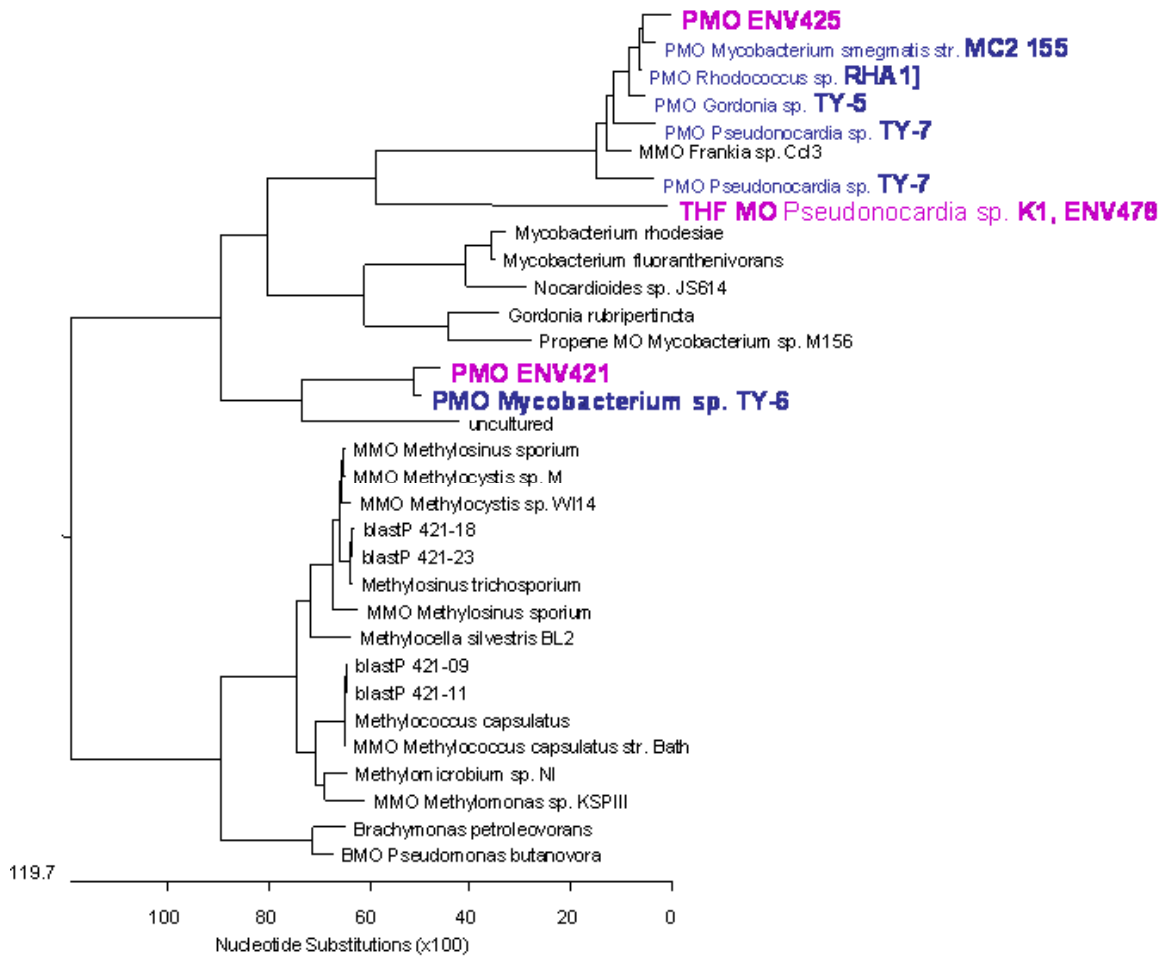

Figure 16. Phylogenetic analysis of diiron containing monooxygenases related to the PMOs investigated in this study.

Using PCR and inverse PCR we were able to obtain the sequence for all of the PMO subunits and many of the accessory genes. We found that over the length of the operon, the PMO of ENV425 was 91, 89, and 87% homologous to the PMOs found in *Rhodococcus* sp strain RHA1, *Mycobacterium smegmatis* MC2, respectively, and 87% homologous to that of *Gordonia* sp strain TY-5. It also shares a similar gene organization with these organisms (Figure 17).

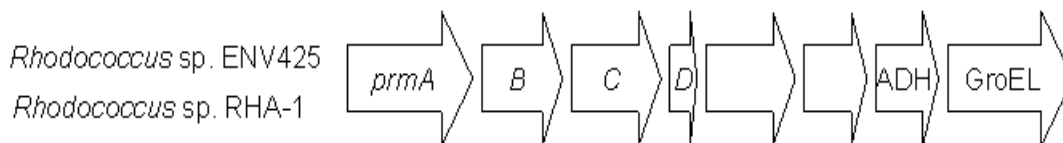

Figure 17. Gene organization of the PMO operon of strain ENV425.

Despite the overall homology of the gene cluster with known sequences, we were unable to obtain the DNA sequence for the 3' end of the putative chaperone gene/peptide (*groEL*) associated with the PMO cluster of strain ENV425. Multiple attempts to PCR

amplify the 3' end of this gene using specific and degenerate primers based on the gene homologues in organisms with closely related gene clusters indicated the *groEL* of ENV425 is substantially different and divergent compared to the structural PMO genes, which could be amplified using both specific and degenerate primers.

The *pmoABCD* genes of strain ENV425 were amplified with PCR primers that created restriction sites so that they could be easily cloned into the protein expression vector pET3A. This plasmid was transferred into *E. coli* BL21(DE3) for expression and activity assays. No propane, THF, or dioxane degradation was evident in the clones screened. It was hypothesized that the presence of the putative *groEL* chaperone might be required for the ENV425 PMO to attain an active conformation in *E. coli*. Chaperone peptides are necessary for correct folding and conformation of some enzymes. Because we were unable to clone the cognate chaperone of ENV425, however, we instead cloned the chaperone system from putative propane monooxygenase system of *Mycobacterium smegmatis* MC2 155. The complete chaperone system (*groES* and *groEL*) was amplified in separate PCR reactions and cloned together in the broad host plasmid PCom8. This plasmid was then transferred into the *E. coli* host containing the clone PMO genes and tested for activity. No active clones were identified. The same chaperone system was also co-expressed with the *thf* operon of ENV478, but again, no active clones were obtained.

III. C. 4c *Mycobacterium* sp. Strain ENV421

Mycobacterium sp. strain ENV421 is a propane oxidizing bacterium that has been studied extensively for its ability to degrade another ether compound, methyl *tert*-butyl ether (MTBE; Steffan et al., 1997)

III. C. 4c1. Molecular analysis. PCR based probing for the three oxygenase sub-families in ENV421 revealed that it carried representatives of all three families. Closer examination revealed that there were 2 members of the SDMOs, multiple P450s, and at least one membrane bound diiron monooxygenase. RT-PCR revealed that following growth on propane ENV421 produced one of each class of oxygenase, making it very difficult to determine which enzyme or enzymes might be transforming 1,4-dioxane. SDMOs such as PMO obviously could play a role in propane oxidation. Membrane bound diiron containing monooxygenases also have been implicated in the oxidation of propane (Johnson and Hyman, 2006) and there are also P450s that are capable of oxidizing linear alkanes (Funhoff et al. 2006). Both SDMOs and P450s can oxidize 1,4-dioxane (Mahendra and Alvarez-Cohen, 2006) or the homolog of dioxane, morpholine (Sielaff and Andreesch. 2005). The membrane bound diiron monooxygenases have also been shown to be capable of oxidizing bulky cyclo-substrates such as norcane, in addition to the more traditional linear alkane substrates (Bertrand et al., 2005). Therefore, it is possible that 1,4-dioxane could enter the active site of this class of enzyme.

III. C. 4c2. P450 analysis. Multiple P450 fragments were amplified with the degenerate P450 primer set. This is not surprising because >20 P450 enzymes have been

identified in a single organism (McLeod et al., 2006). RT-PCR products from propane grown ENV421 cells were cloned and sequenced. The majority of the DNA sequences of the clones had high similarity to cytochrome P450 from *Mycobacterium* sp. HXN-1500, which is involved in limonene and octane oxidation (Funhoff et al. 2006). Another sequence was similar to a cytochrome P450 gene from *Mycobacterium* sp. MCS (YP_640381.1). The substrate range of this enzyme is unknown. The genetic data was confirmed by performing SDS-PAGE separation of cytosolic proteins extracted from succinate and propane grown ENV421 cells (Figure 18).

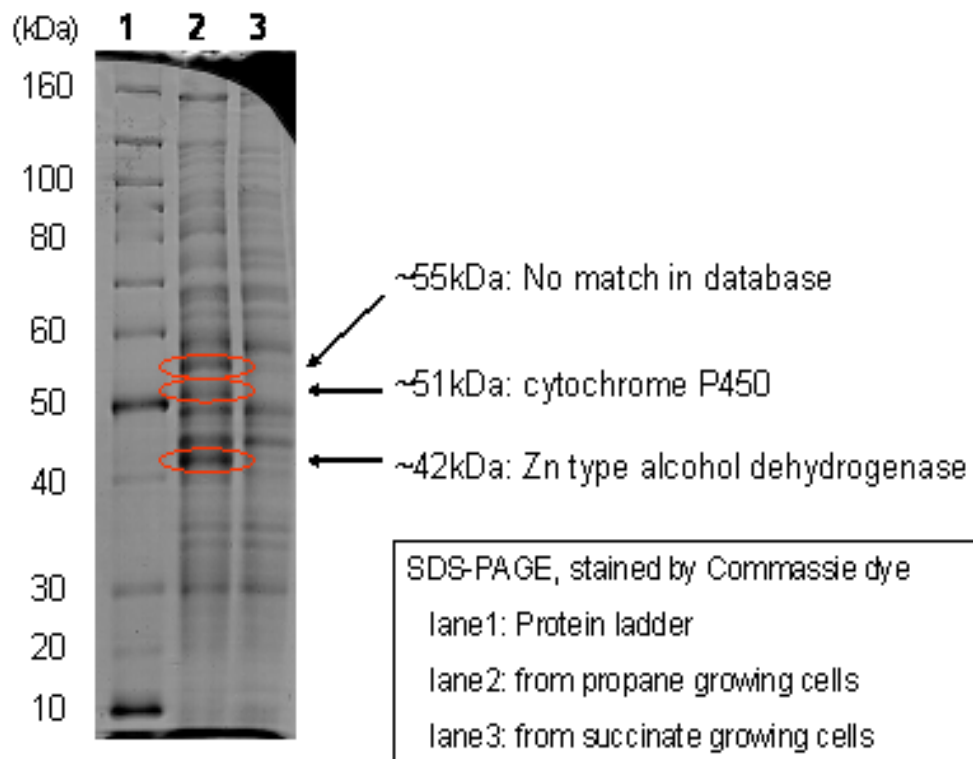

Figure 18. SDS-PAGE separation of cytosolic proteins extracted from propane and succinate grown *Mycobacterium* sp. strain ENV421.

Three propane-induced proteins with sizes of approximately 42 kDa, 51 kDa, and 56 kDa were identified. N-terminal sequencing allowed the identification of the N-terminal 20-amino acid sequence from each protein. The 51 kDa protein was identical to the cytochrome P450 from *Mycobacterium* sp. HXN1500. The 56 kDa band was composed of two distinct peptides. The more abundant of the two is a unique peptide that has not been described previously, whereas the less abundant protein has similarity to a putative aldehyde dehydrogenase from *Nocardia farcinica* IFM 10152. The 42 kDa

band contained a protein similar to a number of zinc-type alcohol dehydrogenases from *Frankia alni* ACN14a or *M. tuberculosis* H37Rv. It also contained a glyceraldehyde-3-phosphate dehydrogenase, type I, from *Mycobacterium* sp. MCS despite the low abundance. An alkane monooxygenase, an alcohol dehydrogenase and an aldehyde dehydrogenase are the three genes required to convert alkanes into fatty acids that can enter the β -oxidation cycle.

We designed PCR primers based on the known sequence of the P450 of *Mycobacterium* sp. HXN1500 and amplified, cloned, and sequenced an operon identical to that the one found in *Mycobacterium* sp. HXN1500 (Figure 19).

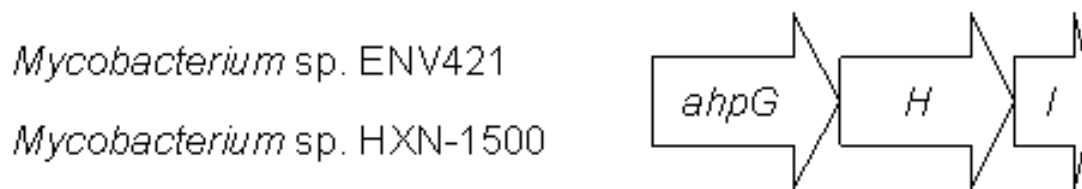
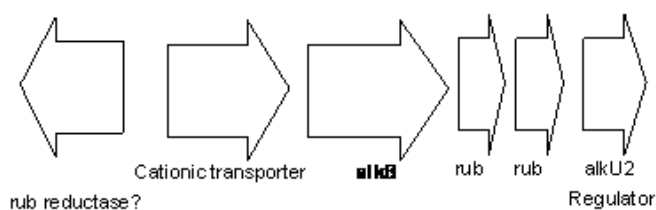

Figure 19. Gene organization of the P450 gene cluster of *Mycobacterium* sp strain ENV421. The genes *ahpGHI* correspond the following functional peptides, hydroxylase, ferredoxin, and ferredoxin reductase.

We performed activity assays using the cloned P450 and found that it did not degrade propane, THF, or 1,4-dioxane. These findings were not unexpected based on previous reports of studies with similar enzymes. For example, with a similar enzyme it was shown that the catalytic rate of hexane oxidation is ~1% of the rate of octane oxidation by the same enzyme. Therefore, because propane is even smaller its oxidation would be expected to be slow. Curiously, colonies expressing the cloned genes converted indole into indigo but only on LB agar plates incubated at room temperature. Incubating them at a higher temperature or in liquid media prevented the transformation from occurring, even if exogenous indole was added. These results suggested that under certain conditions, an active enzyme was produced in the clones.

III. C. 4c3. The membrane bound diiron containing monooxygenase (AlkB). As indicated above, the expression of *alkB* was shown to be induced by propane but not by succinate in ENV421. Southern blot analysis and sequencing of PCR amplified products showed that this organism contained only one isoform of *alkB*. The gene organization of the operon in ENV421, however, is different from that of the canonical alkane monooxygenase cluster from *P. putida* GPo1 (Figure 20).

Mycobacterium sp. ENV421



P. putida GPo1 *AlkB* gene cluster

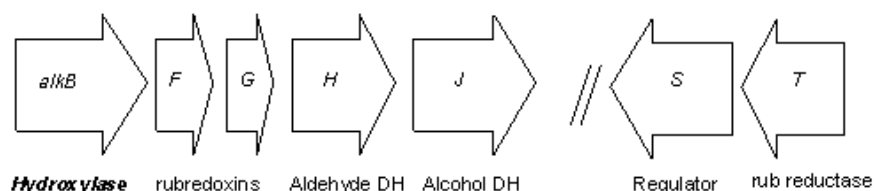

Figure 20. Genetic organization of the *alkB* operon of ENV421 and *P. putida* GPo1.

The DNA sequence of the PCR product showed a high similarity to *alkB* from *Mycobacterium* sp. H37Rv (96% identity). There are at least five putative open reading frames (ORFs) encoded in the same orientation (cationic transporter, alkane monooxygenase, two rubredoxins and a regulatory protein). A rubredoxin reductase, a necessary subunit of alkane hydroxylase complex, is not present in this region of the chromosome of ENV421. The monooxygenase and two rubredoxins (*alkB*, *F* and *G*) were cloned into the pET3A vector for expression analysis. As expected there was no propane, octane, THF, or dioxane degradation observed. These genes were then transferred to a broad-host plasmid (Pcom8) that was then introduced into a derivative of *P. putida* GPo1, that also contained pGec47 Δ B which has all of the genes necessary for growth on octane except *alkB*. This construct did not grow on octane. The reason for the lack of octane oxidation was not determined conclusively. It is well known that different AlkB monooxygenase enzymes are ‘specific’ for linear alkanes of different lengths (or ranges of length) ranging from 5 carbons to >30. These enzymes are roughly divided into three groups that target C₅-C₁₁, C₁₂-C₁₆, and C₁₆-C₂₈. We determined that ENV421 does not grow on octane, thus, the AlkB of ENV421 likely oxidizes larger alkanes. Alternately, it has been noted that although many *alkB* homologs can be functionally expressed in *E. coli* and *P. putida*, not all of them can (Whyte et al., 2002), likely because of an unfavorable distribution of positive charges near the transmembrane stretches of the oxygenase (Smits et al., 1999).

III. C. 4c3. Propane monooxygenase. As indicated by PCR performed with degenerate primers, ENV421 contains multiple isoforms of PMO. The PMO isoform that is expressed during growth on propane (as determined by RT-PCR) is most similar to that of the PMO of *Mycobacterium* sp. TY-6 (Kotani et al. 2006). These two sequences form a gene cluster that is different than other putative propane monooxygenases, sharing less than 30% sequence identity (Figure 16). The gene organization of strain ENV421 also is different than that of strain ENV425. In strain ENV421 and TY-6, the gene order is

prmACDB, while in other species it is *prmABCD*. The DNA sequence of the strain ENV421 PMO was obtained for the entire gene cluster, but a few gaps remain in the sequence. We did not attempt to clone or express this PMO because we were already working with two other SDMOs for strains ENV478 and ENV425.

III. C. 4d. Metabolism of 2HEAA by organisms that grow on linear ethers.

Our initial studies demonstrated that degradation of 1,4-dioxane by THF and propane oxidizing bacteria led to the formation of 2HEAA that was not further degraded by the strains (Vainberg et al., 2006). The inability to metabolize 2HEAA appears to limit growth of these strains on 1,4-dioxane. We hypothesized that organisms that grew on short linear ethers structurally similar to 2HEAA might be able to grow on 2HEAA, and that they may be useful for creating co-cultures or genetically modified organisms that could utilize 1,4-dioxane for growth. We isolated pure cultures that were capable of growth on diglycolic acid (*Ralstonia* sp. strain ENV482), bis-2-chloroethyl ether (*Xanthobacter* sp. strain ENV481), and polyethylene glycol (uncharacterized). Initial experiments showed that these organisms could indeed mineralize labeled 2HEAA as expected, though the presence of co-substrates affected the partitioning of the 2HEAA derived carbon (Table 7). Furthermore, the ENV481 and ENV482 isolates were found to be capable of growth on 2HEAA as a sole source of carbon and energy (Figures 21 and 22).

Table 7. Partitioning of 2HEAA derived [¹⁴C] carbon by *Ralstonia* sp. strain ENV482.

Growth Substrate	Fate of ¹⁴C-2HEAA (%)		
	CO₂	Biomass	Supernatant
Sodium glutamate	43	8	40
DGA	61	16	21
DGA (+DGA in assay)	77	17	2

A standard deviation of no greater than 5 % was observed in the samples.

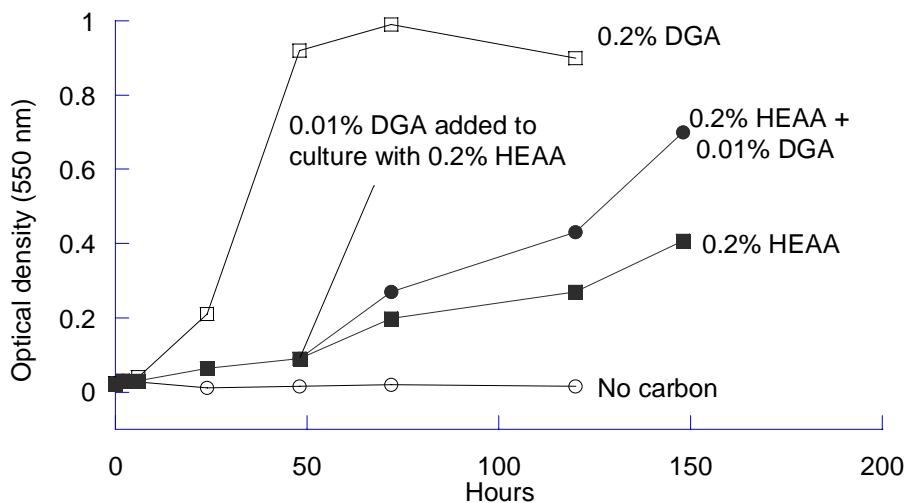

Figure 21. Growth of *Ralstonia* sp. strain ENV482 on 2HEAA

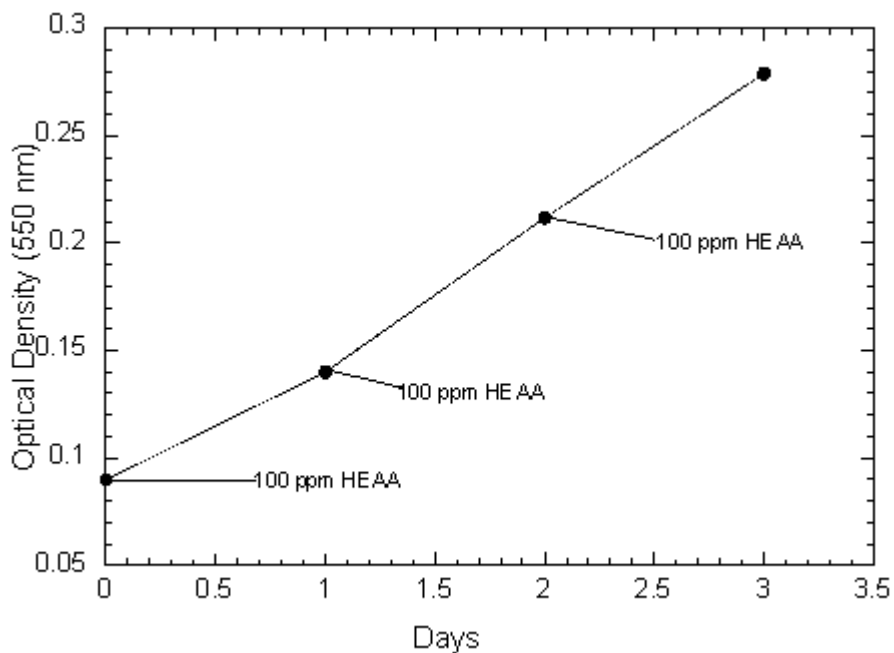

Figure 22. Growth of *Xanthobacter* sp. strain ENV481 on 2HEAA.

We attempted to inhibit the degradation of 2HEAA by strain ENV481 by incubating the cells with reported inhibitors of SDMO and P450 enzymes (acetylene, carbon monoxide, and amino-benzo-triazole) to demonstrate the role of these enzymes in 2HEAA metabolism. A slight decrease in the amount of 2HEAA degraded by the cells was observed when any of the inhibitors was present, however the inhibition was not as great as would be expected if these mechanism based inhibitors were interfering with a monooxygenase catalyzed reaction (Figure 23). Interestingly, at low oxygen levels very

little 2HEAA was degraded by ENV481 (Figure 24). Taken together, these two experiments suggest that neither an SDMO nor a P450 oxygenase is involved in the metabolism of 2HEAA, but that oxygen is still required, perhaps to accept reducing equivalents from NADH generated during a dehydrogenating reaction.

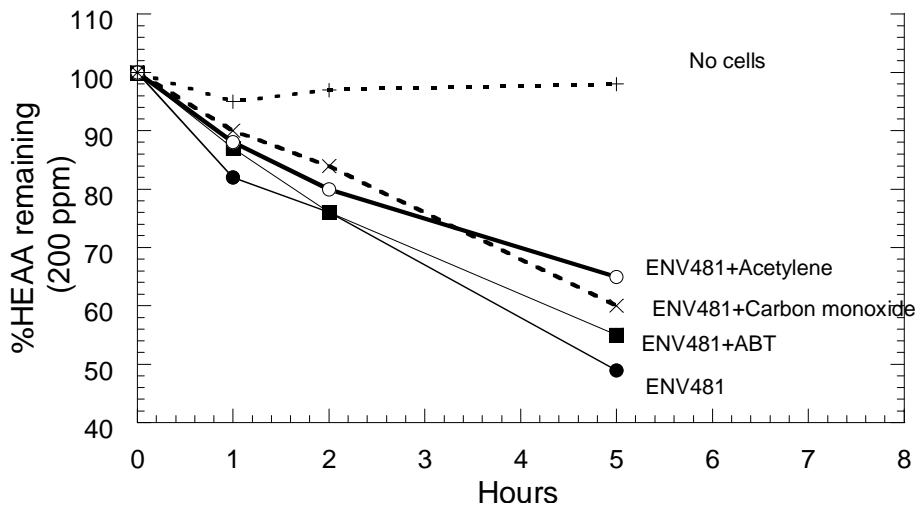

Figure 23. Inhibition of 2HEAA degradation by strain ENV481 in the presence of common monooxygenase inhibitors.

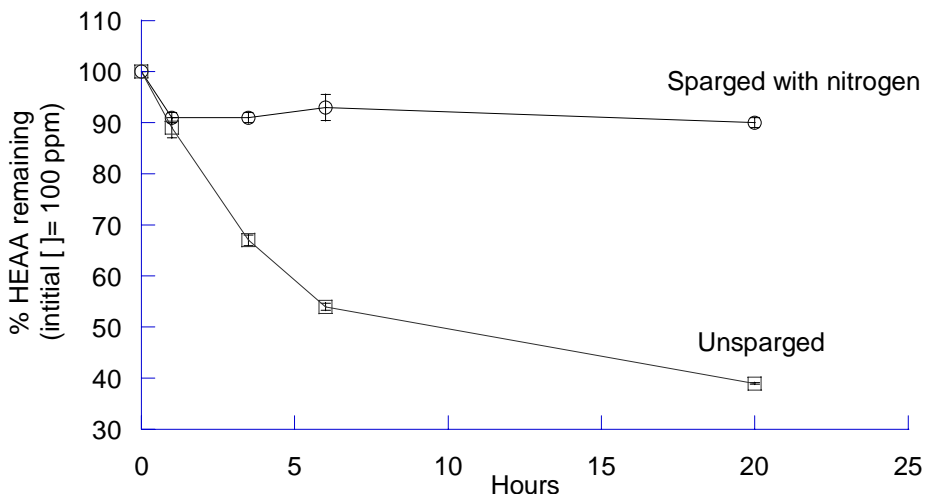

Figure 24. Degradation of 2HEAA in the absence of oxygen with strain ENV481.

Experiments performed with ENV481 and ENV482 showed that when grown in the presence of short linear ethers (DGA and HEAA for ENV482 and diethylene glycol and 2HEAA for ENV481), new peptides were produced (Figure 25). The peptide that was most strongly produced in response to the linear ethers, marked as peptide 2 in Figure 25, was excised from the SDS-PAGE gel for peptide sequence analysis via nano LC/MS/MS. A match for this peptide was found in the protein database. The sequence previously had been identified as the chloroacetaldehyde dehydrogenase (CAD), and it had been isolated from *Xanthobacter autotrophicus*. We designed PCR primers for this peptide and have cloned these genes and are currently performing activity analysis of the clones. Based on the substrate specificity of the CAD gene in *Xanthobacter autotrophicus* it would not be expected that CAD would attack the structurally similar 2HEAA molecule. The fact that it has dehydrogenase activity and is induced by 2HEAA, however, warrants further investigation.

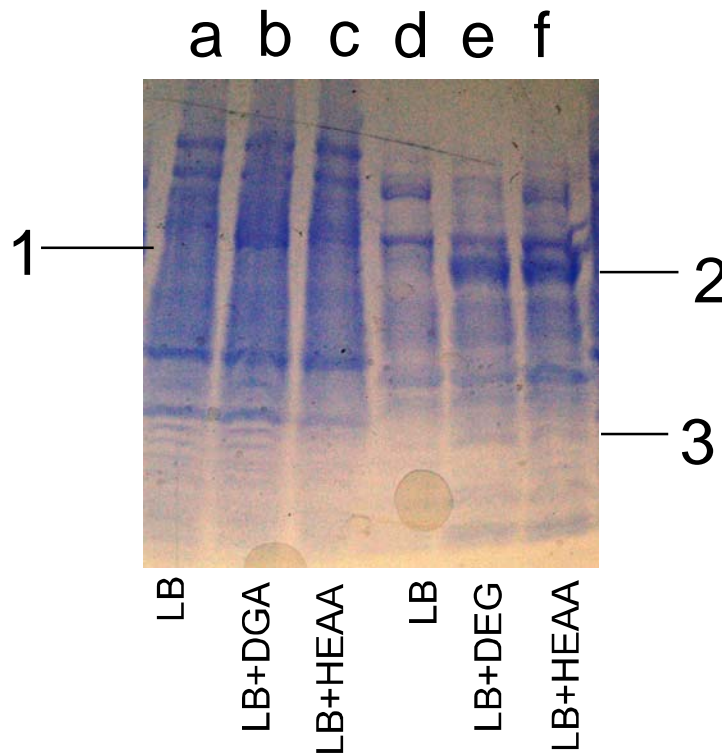

Figure 25. Differential production of peptides in the presence of linear ether substrates by strains ENV481 and ENV482. Lanes a, b, and c, soluble protein extracted from ENV482 when grown on LB and LB+ selected linear ethers (diglycolic acid [DGA] and 2HEAA). Lanes d, e, and f, soluble proteins extracted from ENV481 when grown on LB and LB+ selected linear ethers (diglycolic acid [DGA] and 2HEAA). Peptides produced in response to the presence of linear ethers are indicated by the numbered lines.

III. C. 4d. Superoxide dismutase (SOD). Based on the knowledge that bacterial isolates that grow on DGA also mineralize 2HEAA, we examined the possibility that a superoxide dismutase (SOD) proposed to be involved in the degradation of DGA might also be capable of degrading 2HEAA. A previous report (Yamashita and Kawai, 2004) suggested that *Pseudonocardia* sp. strain K1 produces a bi-functional SOD that also functions as a diglycolic acid dehydrogenase, cleaving diglycolic acid to form a molecule of glycolic acid and glyoxylic acid. We did not have immediate access to *Pseudonocardia* sp. K1 strain, but we did have a strain of *Bacillus cereus* that contained an SOD. We subsequently cloned and expressed this gene in *E. coli*. The SOD of *B. cereus* differed from the SOD of *Pseudonocardia* K1 in only 7 of the possible 208 amino acids positions (Figure 26), and did not degrade 2HEAA or diglycolic acid *in vivo*. Detailed comparison and analysis of the location of the 7 amino acids that differ between these two SODs showed that none of these 7 amino acids are in the immediate vicinity of the catalytically active manganese core of the K1 SOD (Figures 26 and 27). In fact, all of these amino acids are located at the surface of the enzyme.

```

                                X
k1  1MSSFQLPKLSYDYDELEPYIDSNTLSIHGKHHATYVNNLNAALENYSELHNKSLEELLCNLEALPKEIV 70
bc  1MSSFQLPKLSYDYDELEPHIDSNTLSIHGKHHATYVNNLNATLENYTELHNKSLEELLCNLDTLPKEIV 70

                                X
k1  71TAVRNNGGGHYCHSLFWEVMSPRGGGEPNGDVAKVIDYYFNTFDNLKDQLSKAAISRFGSGYGWLVL DGE 140
bc  71TAVRNNGGGHYCHSLFWEVMSPRGGGEPNGDVAKVIDYYFNTFDNLKDQLSKAAISRFGSGYGWLVL DGE 140

                                X   X
k1  141ELTVMSTPNQDTPLQEGKIPLLVIDVWEHAYYLKYQNRPEFVTNWWHTVNWDRVNEKYLQAIQSQKH 208
bc  141ELTVMSTPNQDTPLQEGKIPLLVIDVWEHAYYLKYQNRPEFVTNWWHTVNWDQVNEKYLQAIQSQKH 208

```

Figure 26. Amino acid alignment of the super oxide dismutases of *Pseudonocardia* sp K1 and *Bacillus cereus*. The amino acids that differ between the two peptides are shown with a white background. Amino acids directly involved in binding the catalytic manganese ions are marked with an ‘x’.

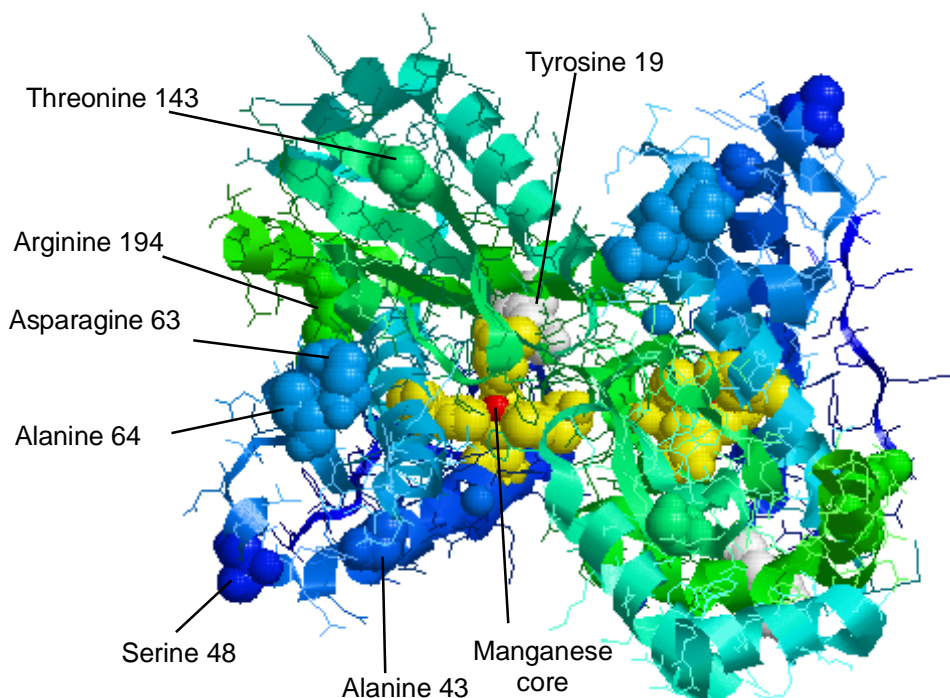

Figure 27. Crystal structure of super oxide dismutase (SOD).

Analysis of this crystal structure revealed that 5 of the 7 amino acids that differ between the SODs of *Pseudonocardia* sp strain K1 and *Bacillus cereus* are located at the ends of the α -helices that are involved in the binding of the catalytically active manganese ion. The amino acids are labeled as they exist in the SOD of *Pseudonocardia* sp. strain K1. The 5 amino acids at positions 19, 43, 48, 63, and 64 are all located at the terminal ends of alpha helices that contain the manganese ligands of the SOD. While none of these amino acids appear to be located in a position that would allow them to directly control access to the presumptive active site of the enzyme, they could indirectly affect access of substrates to the catalytic core.

We used site directed mutagenesis to make 7 amino acid substitutions in the cloned *B. cereus* SOD, resulting in a SOD isoform identical to the *Pseudonocardia* sp. strain K1 SOD. These mutations were verified via DNA sequence analysis. This new isoform was then expressed in *E. coli* (production of active SOD was verified using a colorimetric xanthine oxidase inhibition assay [Dojindo Molecular Technologies Inc., Kumamoto, Japan]) and assayed to determine if it was capable of degrading 2HEAA. The SOD expressing culture did not convert radio labeled 2HEAA to carbon dioxide, as would be expected if 2HEAA was being hydrolyzed given that *E. coli* is capable of utilizing one of the 2HEAA hydrolysis products (glyoxylate) as a carbon source.

Furthermore, HPLC analysis of the culture supernatant showed that there was a single radioactive peak, corresponding to 2HEAA, at the end of the assay. This indicated that no hydrolysis products had been produced from 2HEAA by the cloned SOD gene/enzyme. This data suggests that the wild type SOD of *Pseudonocardia* sp. strain

K1 is not involved in the hydrolysis of 2HEAA. It is important to note that *Pseudonocardia* sp. strain K1 does not appear to grow on 1,4-dioxane (Mahendra and Alvarez-Cohen, 2006) even though it appears to have the enzymes necessary to do so.

In related studies, a SOD gene was found in a culture known to mineralize 2HEAA. A SOD gene amplified from the *Pseudonocardia dioxanivorans* CB1190 culture was found to be identical to the SOD gene of *B. cereus*, but not *Pseudonocardia* sp. strain K1, suggesting that the difference between the SOD gene of *B. cereus* and *Pseudonocardia* sp. strain K1 did not account for the ability of *Pseudonocardia* sp. strain K1 to degrade diglycolic acid. Furthermore, because neither the SOD isoform of *B. cereus* or *Pseudonocardia* sp. strain K1 allowed *E. coli* to degrade 2HEAA, it also is unlikely that CB1190 hydrolyzes 2HEAA with this SOD enzyme.

A second SOD gene was amplified from a culture that was isolated on polyethylene glycol and also degrades 2HEAA. This gene was not sequenced but rather was expressed in *E. coli* to see if it was responsible for the degradation of 2HEAA. This clone also failed to produce any detectable 2HEAA hydrolysis.

While the SOD enzyme may or may not be responsible for the degradation of diglycolic acid in *Pseudonocardia* sp. strain K1, we are forced to conclude that the expression of various SOD genes in *E. coli* is not sufficient to cause the hydrolysis of 2HEAA. It is noted that in both cell-free and whole cell assays where the cloned version of the SOD from *Pseudonocardia* sp. strain K1 was used to hydrolyze diglycolic acid, the free radical generator phenazine methosulfate was included in the assay, as reported by Yamashita et al (2004). It is not immediately obvious why free radicals would be required for SOD to perform its purported function as a diglycolic acid dehydrogenase. However, when SOD acts on superoxide, hydrogen peroxide is produced. It might be that SOD requires either superoxide or hydrogen peroxide to cleave ethers or that superoxide or hydrogen peroxide themselves are responsible for the ether cleavage. Unfortunately, phenazine methosulfate is not a physiologically relevant compound and can not be involved in 1,4-dioxane mineralization *in vivo*.

III. D. Discussion of molecular biological studies

III. D. 1. Analysis of the 1,4-dioxane biodegradation pathway.

Pseudonocardia sp. strains are widely distributed nocardioform actinomycetes that are abundant in many environments and known to degrade a wide range of pollutants. Strain ENV478 and at least two other *Pseudonocardia* strains have now been shown to degrade the cyclic mono-ether THF (Kohlweyer et al., 2000; Parales et al., 1994), and to co-metabolically degrade 1,4-dioxane after growth on THF. *P. dioxanivorans* strain CB1190 (Mahendra and Alvarez-Cohen, 2005; Parales et al., 1994) was isolated from a THF enrichment and is the only *Pseudonocardia* strain known to grow on 1,4-dioxane as a sole carbon source. A related strain, *Pseudonocardia* sp. strain K1 (Kohlweyer et al., 2000) also grows on THF, but not 1,4-dioxane, and has been studied in detail leading to the cloning and analysis of an apparent THF oxidation operon.

In this study, we isolated a new organism, strain ENV478, that is phylogenetically related to strains CB1190, but is not able to grow on 1,4-dioxane as a sole carbon source even though it appears that the same enzyme(s) in the strain is required to oxidize both substrates (Figure 6). The inability of strain ENV478 and other THF degraders to grow on 1,4-dioxane could be related to a number of factors including the lack of induction of the requisite enzyme(s) by 1,4-dioxane, or an inability to efficiently process metabolites for energy production.

THF degradation by *Pseudonocardia* strain K1 is facilitated by a plasmid-borne, NADH-dependant, multi-component, binuclear-iron THF monooxygenase (ThfMO) (Theimer et al., 2003). Consequently, growth on THF requires the expenditure of energy (i.e., for NADH generation) for the primary oxidation. 1,4-dioxane degradation by strain ENV478 was greatest after growth on THF, and the presence of THF inhibited 1,4-dioxane degradation by the strain (Figure 6). Furthermore, the strain appeared to accumulate 2HEAA, an expected product of a monooxygenation reaction with 1,4-dioxane, during 1,4-dioxane degradation. Therefore, we conclude that degradation of 1,4-dioxane and THF by strain ENV478 involves an initial oxidation of the cyclic ether by a monooxygenase that presumably is homologous to the THF monooxygenase of strain K1. Because strain ENV478 also can degrade propane, however, the role of a short chain alkane monooxygenase, some of which are known to oxidize ethers (Steffan et al., 1997) including, possibly, 1,4-dioxane (Burback and Perry, 1993), can not be completely ruled out. However, the relatively low activity of propane grown cells (Fig. 3) suggests that this is a minor catalyst in this strain. Conversely, an alkane monooxygenase may be more important in BCEE oxidation by strain ENV478 because it degraded BCEE faster after growth on propane than THF.

The initial monooxidation of 1,4-dioxane likely results in the production of 1,4-dioxane-2-ol, the hemiacetal of 2-hydroxyethoxy-2-acetaldehyde (Figure 3,9). This compound could be oxidized by an alcohol dehydrogenase, or, because of the inherent instability of hemiacetals in water, be chemically oxidized through the hydroxyaldehyde intermediate to 2HEAA. Although under some circumstances the 2HEAA could form PDX, this product is unlikely in aqueous solutions, especially under the near-neutral pH of our cultures. Our attempts to isolate PDX from our cultures of ENV478 have been unsuccessful, and even when we attempted to synthesize this compound in our laboratory, at pH>3 it was difficult to obtain PDX without 2HEAA present. The 1,4-dioxane biodegradation pathway in ENV478, therefore, appears similar to the 1,4-dioxane metabolic pathway proposed for rats (Braun and Young, 1977; Woo et al., 1977) (Figure 3). During the performance of this project we examined the 1,4-dioxane pathway of seven organisms that grow on a diverse range of substrates including toluene, THF, and propane. We found that irrespective of which organism performed the catalysis, the end result was the same; conversion of 1,4-dioxane to 2HEAA.

Interestingly, in 1,4-dioxane biodegradation studies with a pure culture of fungi, Nakamiya and colleagues (2005) observed only ethylene glycol, glycolic acid, and oxalic acid as 1,4-dioxane degradation products. This suggests that either an alternative degradation pathway is present in fungi, or that 2HEAA is rapidly degraded to these

products by the fungi and not detected in analyses performed for that study. Degradation of 2HEAA to these products could be facilitated by a dehydrogenase related to the diglycolic acid dehydrogenase of strain K1 which cleaves ether bonds adjacent to terminal carboxyl groups in both short chain ethers (diglycolic acid) and long chain polymers (polyethylene glycol) (Yamashita, et al. 2004). A lack of a similar enzyme activity in ENV478, or a stringent substrate range that does not allow the enzyme to cleave 2HEAA as may be the case in strain K1, may prevent these strains from metabolizing 2HEAA, resulting in their inability to grow on 1,4-dioxane. Parales and co-workers (1994) suggested that long-term incubation of their THF degrading cultures with THF and periodic additions of 1,4-dioxane may have led to a mutation that allowed strain CB1190 to grow on 1,4-dioxane. Our results suggest that such a mutation may have allowed the strain to metabolize 2HEAA, but to our knowledge CB1190 cultures have never been analyzed for this 1,4-dioxane metabolite or for 2HEAA metabolizing enzyme activity.

The inability of 1,4-dioxane to induce the ThfMO homolog genes in strain ENV478 also could limit the strain's ability to grow on 1,4-dioxane by limiting the supply of enzyme needed to continuously process 1,4-dioxane. Expression of ThfMO appears tightly regulated in strain K1 (Theimer et al., 2003). Northern blot analysis demonstrated that the monooxygenase was produced during growth on THF, but not after growth on succinate. Conversely, we demonstrated that strain ENV478 can degrade 1,4-dioxane even after growth on alternative substrates (Figure 2), albeit at a lower rate than in fully induced THF-grown cells. This means that the apparent ThfMO of strain ENV478 is expressed constitutively, and can be induced to even higher levels during growth on THF. The constitutively expressed enzyme may be enough to support prolonged degradation of 1,4-dioxane under certain conditions in the field, as we observed in our microcosms studies where 1,4-dioxane was degraded for >80 days (Fig. 28). The presence of alternative unidentified inducers in the microcosm studies, however, cannot be ruled out (Johnson et al., 2004).

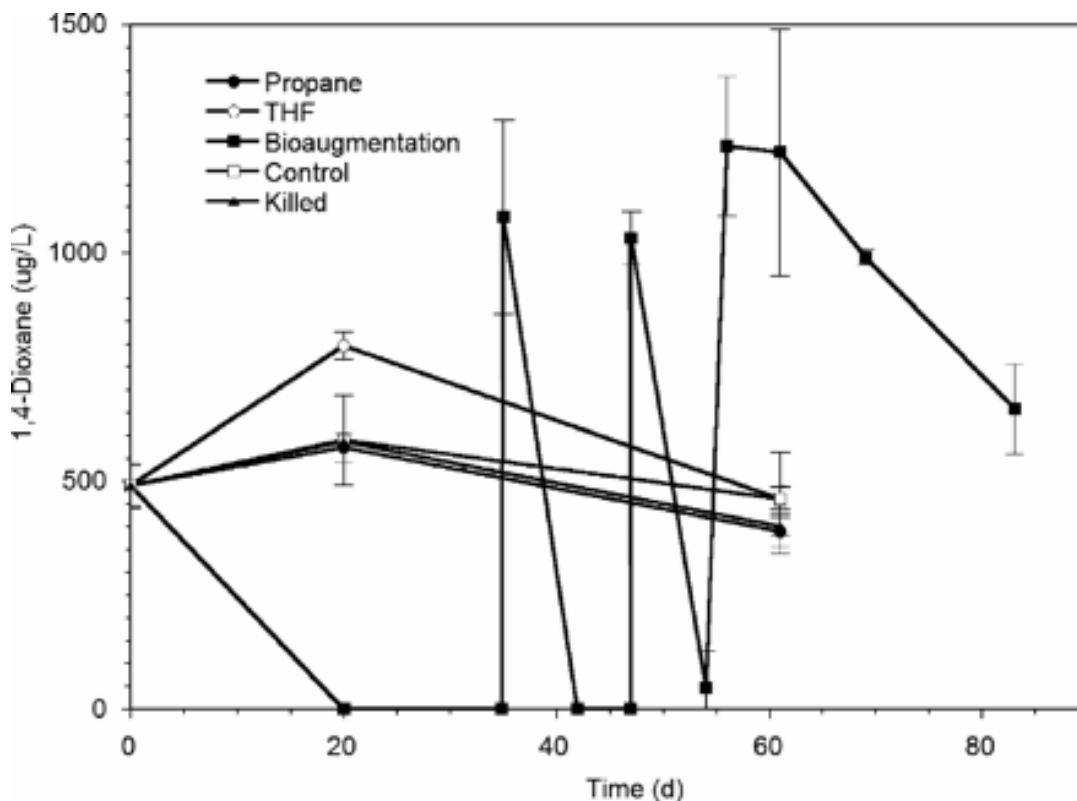

Figure 28. Biodegradation of 1,4-dioxane in aerobic aquifer microcosms. The different treatments are described in Materials and Methods. "Bioaugmentation" microcosms received THF-grown strain ENV478 (18 mg TSS each). The initial 1,4-dioxane concentration in the site samples was ~500 $\mu\text{g}/\text{liter}$, and additional 1,4-dioxane was added to the bioaugmentation microcosms on days 35, 46, and 53. The symbols indicate means ($n = 3$), and the error bars indicate one standard error.

Poor induction of down stream enzymes also might limit the processing of 1,4-dioxane metabolites to support the growth of ENV478 on this compound. Although no genes that are obviously involved in 2HEAA metabolism are apparent in the cloned THF operon of strain K1, the strain does produce a diglycolic acid dehydrogenase that cleaves ether bonds adjacent to terminal carboxyl groups in short chain ethers (Yamashita, et al. 2005). The lack of such activity, or the inability of 1,4-dioxane or its metabolites to induce this or similar activity in strain ENV478 also could limit 2HEAA metabolism. To test the ability of THF to induce 2HEAA metabolism by strain ENV478, cultures that had accumulated 2HEAA were fed THF. Although the added THF was readily degraded, no further degradation of 2HEAA was observed (data not shown), indicating that THF and its metabolites probably do not induce the expression of genes necessary for 2HEAA metabolism in strain ENV478. Additional studies are underway to further investigate the presence or absence and induction of potential 2HEAA degradation genes in ENV478.

III. D. 2. Analysis of 1,4-dioxane degradation genes. We attempted to gain further insight into the process by which dioxane is metabolized by determining which class or classes of monooxygenase catalyze the initial oxidation of 1,4-dioxane. In the

simplest case, where we were to conditionally express the cloned toluene-4-monooxygenase, we showed that T4MO is capable of converting 1,4-dioxane to the terminal product 2HEAA, demonstrating that soluble diiron monooxygenases can perform this function. These findings were simultaneously generated by another research group (Mahendra and Alvarez-Cohen, 2006). With the wild type organisms tested during this project, however, the process of proving which enzymes were involved in 1,4-dioxane degradation was more complex because the organisms studied in detail all contained representatives of all three monooxygenase sub-families that were considered as possible agents of 1,4-dioxane oxidation. Transcriptional analysis of strains ENV478, ENV421 and ENV425 following growth on substrates that promote degradation of 1,4-dioxane revealed that, depending on which strain was being examined, enzymes belonging to all three enzyme classes were being produced (Table 8). It is important to note that only the SDMO class of oxygenase was produced in all three cases. This is also the enzyme class to which T4MO belongs. Taken together, this project has provided additional evidence that enzymes responsible for 1,4-dioxane degradation in THF and propane oxidizing bacteria belong to the SDMO group of enzymes.

Table 8. Oxygenases produced during growth on substrates that promote 1,4-dioxane degradation.

Strain	Growth substrate	Oxygenase expressed		
		SDMO	P450	MBMO
ENV478	THF	yes	yes	no
ENV421	Propane	yes	yes	yes
ENV425	Propane	yes	no	no

Extensive molecular biological studies were performed to identify and confirm the genes involved in bacterial 1,4-dioxane degradation. We cloned and sequenced four different monooxygenase gene systems (2 soluble diiron monooxygenases [SDMOs], 1 P450 monooxygenase, and 1 membrane bound monooxygenase [MBMO]) with the intention of demonstrating their activity in heterologous hosts, but we were unable to functionally express the genes in *E. coli* and other heterologous hosts. We focused primarily on the tetrahydrofuran monooxygenase (ThfMO) and the propane monooxygenase (PMO) genes of strains ENV478 and ENV425, trying a number of techniques to alleviate potentially problematic gene structures such as resolving overlapping reading frames, substituting less than favorable ribosomal binding sites and start codons with better ones, employing strong expression systems (pET3A plasmids), and using modified hosts with increased capacity to translate infrequently used codons. Using SDS-PAGE analysis we were able to show that the peptides of interest were being produced (in the case of ThfMO) in the heterologous hosts, but no catalytic activity was observed. Accordingly, we tried other approaches including transferring the genes to broad host vectors and using different expression hosts including *P. putida* and *M. smegmatis*. Still, the cloned SDMO genes could not be functionally expressed. We have noted that while several soluble diiron monooxygenases have been cloned and expressed in *E. coli*, there are many that can not yet be expressed successfully. Among these are the methane monooxygenase of *M. trichosporium* OB3b, the *thm* cluster of *Pseudonocardia*

sp. strain K1, the *prm* cluster of *Gordonia* TY-5, the alkene monooxygenases of *Rhodococcus rhodococcus* B-276 (Smith et al., 1999), *Mycobacterium* sp. strain M156 (Chan et al., 2005) and *Xanthobacter autotrophicus* PY2 (Champreda et al., 2004), and during this study the THF and PMO clusters of strains ENV478 and ENV425.

It is of interest to note that the proven or putative propane monooxygenase operons of *Rhodococcus* sp. RHA1, *Mycobacterium smegmatis* MC2 155, *Gordonia* sp. TY-5, *Frankia* sp. CcI3, as well as that of ENV425 are all followed by a gene for an isoform of the chaperone protein GroEL. We have not yet been able to demonstrate the existence of PMO-associated GroEL type chaperone in strain ENV421. Analysis of the full genome sequences of strains RHA1, MC2 and CcI3 revealed that these organisms have 2, 3, and 4 isoforms of GroEL, respectively. The association of these diiron monooxygenases with a single isoform of GroEL is probably more than mere coincidence. The limited phylogenetic distribution of these enzymes among bacteria, together with available genetic evidence, indicates that they have been spread largely through horizontal gene transfer (Leahy et al., 2003). Furthermore, it has been previously shown that GroEL can be modified by directed evolution to acquire or improve its ability to correctly fold proteins that do not fold well in a heterologous host (Makino et al., 1997). It is possible that the reason that a unique isoform of GroEL is retained in these organisms and associated with the diiron monooxygenases is because they have unique folding requirements that are not met by the hosts' more general chaperone system. Likewise, the chosen heterologous hosts may not have heterologous GroEL chaperone systems. We attempted to pursue this hypothesis by cloning and expressing the GroEL/ES chaperone system(s) from *Mycobacterium smegmatis* MC2 155 in conjunction with the expression of the diiron monooxygenases of strains ENV425 and ENV478. This approach did not result in the expected catalytic activity from either enzyme system. It is not currently known if the potential chaperone requirements of these enzymes are so specific that only the enzymes' cognate chaperone can fulfill the role, or if the difficulty in attaining expression is unrelated to the chaperones.

The P450 gene cloned from ENV421 showed some enzymatic activity, converting indole into indigo on LB agar plates, however, no degradation of 1,4-dioxane was observed. Oddly, the addition of exogenous indole and strong induction of the enzyme system did not result in the production of more indigo. Furthermore, indigo production was decreased when the cells were incubated at higher temperature (37°C) as opposed the room temperature. All of these factors suggest improper folding of the cloned P450 enzymes.

Similar results were obtained with the AlkB type membrane bound monooxygenase of strain ENV421. The genes were cloned and peptides were produced, but catalytic activity towards the target substrates (propane, octane, THF, and dioxane) could not be demonstrated with the various hosts used (*E. coli* and *P. putida* GPo12-pGEc47 Δ B). It is possible that the substrate range of this particular AlkB homolog lies outside of the substrate range we tested.

In the absence of expression of the cloned enzymes in a heterologous host we attempted to create ThfMO knockout mutants in strain ENV478 by trying to substitute, via homologous recombination, the functional ThfMO operon with one that had been disrupted by a plasmid derived gene encoding for kanamycin resistance. The low transformation efficiency of this strain coupled with its slow growth rate limited our progress. Nonetheless, individual Km^r colonies were isolated, but they all retained the wild type ThfMO. This suggests that either a single cross over event or illegitimate recombination occurred. As mentioned previously, we are currently still pursuing this avenue of research because we believe that the desired mutant will be isolated.

Because none of our lab strains or environmental isolates that could initiate the degradation of 1,4-dioxane were able to metabolize 2HEAA, we further evaluated the metabolism of this compound. Several pure and mixed bacterial cultures can readily mineralize 2HEAA. Our investigation into the mechanism and enzymes involved in 2HEAA degradation, however, was not conclusive but indicated that the process is probably not mediated by a monooxygenase even though the presence of oxygen appeared important for 2HEAA metabolism.

Three unexpected and interesting observations were made during the performance of this project. First, many SDMOs from Gram positive bacteria were very difficult to express in heterologous hosts. Genetic data acquired here and in unrelated projects has shown that many SDMOs are associated with an isoform of the chaperone GroEL, and that the required GroEL is dissimilar from native GroEL isoforms in the host cells. This implies that the putative chaperone performs a special function and could be necessary for the proper folding of SDMOs in Gram positive organisms. Second, we noted that *Mycobacterium* sp. strain ENV421 produces three distinct monooxygenases when grown on propane as a sole substrate. The simultaneous production of three distinct monooxygenases in response to a single, simple, growth substrate is intriguing. The induction of several catalytic enzymes in response to a single inducer, if common place in *Mycobacteria* species, could explain the remarkably broad substrate range of *Mycobacteria* such as the well studied *Mycobacterium vaccae* strain JOB5 (Streger et al. 1999., Murphy and Perry, 1983, Hamamura et al., 1997). Finally, we began to investigate the enzymology of 2HEAA degradation, an important intermediate produced during degradation of 1,4-dioxane (Vainberg et al., 2006) and another important pollutant, *bis*-(2-chloroethyl) ether (BCEE; McClay et al., submitted; Appendix 3). Our data to date suggests that an enzyme system other than a P450 or SDMO catalyzes this transformation. We plan to continue investigating this important reaction.

III. E. Molecular analysis conclusion.

During this project we did complete the first elucidation of a bacterial biodegradation pathway for 1,4-dioxane. Each of the strains tested co-metabolically degraded 1,4-dioxane after growth on either propane or THF. 1,4-dioxane degradation resulted in the production of 2HEAA that was not further oxidized by the strains tested, although it was degraded by other organisms and in environmental samples. From these studies we conclude that the inability to metabolize 2HEAA, and thereby generate energy

to support the oxidation of 1,4-dioxane, is likely a significant contributing factor preventing biological degradation of 1,4-dioxane. Likewise, the inability of 1,4-dioxane to induce propane and THF monooxygenase genes may also contribute to the recalcitrance of 1,4-dioxane.

Extensive molecular biological analysis of 1,4-dioxane degrading bacteria revealed that each of them produced multiple and diverse monooxygenase enzymes, many of which are induced during growth on their primary substrates. Although none of the cloned genes could be functionally expressed in heterologous hosts strains, evidence generated suggested that broad substrate soluble diiron monooxygenase enzymes are the most likely catalysts of co-metabolic 1,4-dioxane degradation.

IV. SUMMARY

Results of this study demonstrated the recalcitrance of 1,4-dioxane. Although several organisms were shown to degrade 1,4-dioxane via cometabolism during growth on propane or THF, 1,4-dioxane was not degraded in microcosms created with samples from two different aquifers regardless of the redox conditions employed. Likewise, 1,4-dioxane was not degraded in samples from 2 different treatment systems that had been exposed to 1,4-dioxane for extended periods. No bacteria that could grow on 1,4-dioxane were enriched or isolated from the 4 systems tested. Therefore, results of this study demonstrate that biological treatment and natural biological attenuation are unlikely to be successful remedial alternatives for 1,4-dioxane contaminated sites.

During this project we did complete the first elucidation of a bacterial biodegradation pathway for 1,4-dioxane. Each of the strains tested co-metabolically degraded 1,4-dioxane after growth on either propane or THF. 1,4-dioxane degradation resulted in the production of 2HEAA that was not further oxidized by the strains tested, although it was degraded by other organisms and in environmental samples. From these studies we conclude that the inability to metabolize 2HEAA, and thereby generate energy to support the oxidation of 1,4-dioxane, is likely a significant contributing factor preventing biological degradation of 1,4-dioxane. Likewise, the inability of 1,4-dioxane to induce propane and THF monooxygenase genes may also contribute to the recalcitrance of 1,4-dioxane.

Extensive molecular biological analysis of 1,4-dioxane degrading bacteria revealed that each of them produced multiple and diverse monooxygenase enzymes, many of which are induced during growth on their primary substrates. Although none of the cloned genes could be functionally expressed in heterologous hosts strains, evidence generated suggested that broad substrate soluble diiron monooxygenase enzymes are the most likely catalysts of co-metabolic 1,4-dioxane degradation.

V. REFERENCES

- Adams, C.D., P.A. Scanlan, and N.D. Secrist. 1994. Oxidation and biodegradability enhancement of 1,4-dioxane using hydrogen peroxide and ozone. *Environ. Sci. Technol.* 28:1812-1818.
- Altschul, S.F., T.L. Madden, A.A. Schäffer, J. Zhang, Z. Zhang, M. Miller, and D.J. Lipman. 1997. Gapped BLAST and PSI-BLAST: a new generation of protein database search programs, *Nucleic Acids Res.* 25:3389-3402.
- Bernhardt, D., and H. Diekmann. 1991. Degradation of dioxane, tetrahydrofuran and other cyclic ethers by an environmental *Rhodococcus* strain. *Appl. Microbiol. Biotechnol.* 36:120-123.
- Bertrand, E., R. Sakai, E. Rozhkova-Novosad, L. Moe, B.G. Fox, J.T. Groves, and R.N. Austin. 2005. Reaction mechanisms of non-heme diiron hydroxylases characterized in whole cells. *J. Inorg. Biochem.* 99:1998-2006.
- Bowman, R.H., P. Miller, M. Purchase, and R. Schoellerman. 2001. Ozone-peroxide advanced oxidation water treatment system for treatment of chlorinated solvents and 1,4-dioxane. *Proc. Amer. Chem. Soc. National Meeting*, San Diego, April 3, 2001.
- Bradley, P. M., F. H. Chapelle, and J. E. Landmeyer. 2001a. Methyl *t*-butyl ether mineralization in surface-water sediment microcosms under denitrifying conditions. *Appl. Environ. Microbiol.* 67:1975-1978.
- Bradley, P. M., J. E. Landmeyer, and F.H. Chapelle. 2001b. Widespread potential for microbial MTBE degradation in surface-water sediments. *Environ. Sci. Technol.* 35:658-662.
- Braun, W.H., and J.D. Young. 1977. Identification of γ -hydroxyethoxyacetic acid as the major urinary metabolite of 1,4-dioxane in the rat. *Toxicol. Appl. Pharmacol.* 39:33-38.
- Burback, B.L., and J.J. Perry. 1993. Biodegradation and biotransformation of groundwater pollutant mixtures by *Mycobacterium vaccae*. *Appl. Environ. Microbiol.* 59:1025-1029.
- Champreda, V., N.Y.Zhou, and D.J. Leak. 2004. Heterologous expression of alkene monooxygenase components from *Xanthobacter autotrophicus* Py2 and reconstitution of the active complex. *FEMS Microbiol. Lett.* 239:309-18.
- Chan Kwo Chion, C.K., S.E.Askew, and D.J. Leak. 2005. Cloning, expression, and site-directed mutagenesis of the propene monooxygenase genes from *Mycobacterium* sp. strain M156. *Appl. Environ. Microbiol.* 71(4):1909-14.

- Chiba, K., Y. Hoshino, K. Ishino, T. Kogure, Y. Mikami, Y. Uehara, and J. Ishikawa. 2007. Construction of a pair of practical *Nocardia-Escherichia coli* shuttle vectors. *Jpn. J. Infect. Dis.* 60:45-47.
- Cole, J.R., B. Chai, R.J. Farris, Q. Wang, A.S. Kulam-Syed-Mohideen, D.M. McGarrel, A.M. Bandela, E. Cardenas, G.M. Garrity, and J.M. Tiedje. 2005. The ribosomal database project (RDP-II): introducing myRDP space and quality controlled public data. *Nucleic Acids Res.* 35:D169-172.
- Cowan, R. M., et al. 1994. Isolation and identification of microorganisms responsible for 1,4-dioxane mineralization. 94th ASM General Meeting. Abstract Q444.
- Daye, K.J., J.C. Groff, A.C. Kirpekar, and R. Mazumder. 2003. High efficiency degradation of tetrahydrofuran (THF) using a membrane bioreactor: identification of THF-degrading cultures of *Pseudonocardia* sp. strain M1 and *Rhodococcus ruber* isolate M2. *J. Ind. Microbiol. Biotechnol.* 30:705-714.
- de Lorenzo, V., M. Herrero, U. Jakubzik, K.N. Timmis. 1990. Mini-Tn5 transposon derivatives for insertion mutagenesis, promoter probing, and chromosomal insertion of cloned DNA in gram-negative eubacteria. *J. Bacteriol.* 172:6568-6572.
- Elliott, S.J, M. Zhu, L. Tso, H. Hoa T. Nguyen, J.H.K. Yip, and S.I. Chan. 1999. Regio- and stereoselectivity of particulate methane monooxygenase from *Methylococcus capsulatus* (Bath). *J. Am. Chem. Soc.* 119(42):9939-9948.
- Fincher, E.L., and W.J. Payne. 1962. Bacterial utilization of ether glycols. *Appl. Microbiol.* 10:542-547.
- Finnernan, K.T. and Lovely, D.R. 2001. Anaerobic degradation of methyl tert-butyl ether (MTBE) and tert-butyl alcohol (TBA). *Environ. Sci. Technol.* 35:1785-1790.
- Francis, A. J., et al. 1980. *Nucl. Technol.* 50:15-163.
- Funhoff, E.G., U. Bauer, I. Garcia-Rubio, B. Witholt, and J.B. van Beilen. 2006. CYP153A6, a soluble P450 oxygenase catalyzing terminal-alkane hydroxylation. *J. Bacteriol.* 188:5220-5227.
- Hamamura N., C. Page, T. Long, L. Semprini, D.J. Arp. 1997. Chloroform Cometabolism by butane-gown CF8, *Pseudomonas butanovora*, and *Mycobacterium vaccae* JOB5 and methane-gown *Methylosinus trichosporium* OB3b. *Appl Environ Microbiol.* 63:3607-3613.
- Hareland, W., R.L. Crawford, P.J. Chapman, and S. Dagley. 1975. Metabolic function and properties of 4-hydroxyphenylacetic acid 1-hydroxylase from *Pseudomonas acidovorans*. *J. Bacteriol.* 121:272-285.

- Hyman, M. 1999. Final Report: Aerobic cometabolism of ether-bonded compounds. <http://es.epa.gov/ncer/final/grants/95/envbio/hyman.html>.
- Jackson, R.E., and V. Dwarakanath. 1999. Chlorinated degreasing solvents: physical-chemical properties affecting aquifer contamination and remediation. *Ground Water Monit. Remediation* 19:102-110.
- Johnson, E.L., C.A. Smith, K.T. O'Reilly, and M.R. Hyman. 2004. Induction of methyl tertiary butyl ether (MTBE)-oxidizing activity in *Mycobacterium vaccae* JOB5 by MTBE. *Appl. Environ. Microbiol.* 70:1023-1030.
- Johnson, E.L., and Hyman M.R. 2006. Propane and n-butane oxidation by *Pseudomonas putida* GPo1. *Appl Environ Microbiol.* 72:950-952.
- Kampfer P., and R.M. Kroppenstedt. 2004. *Pseudonocardia benzenivorans* sp. nov. *Int. J. Syst. Evol. Microbiol.* 54(Pt 3):749-51.
- Kaneda, K., S. Imaizumi, S. Mizuno, T. Baba, M. Tsukamura, I. Yano. 1988. Structure and molecular species composition of three homologous series of alpha-mycolic acids from *Mycobacterium* spp. *J. Gen. Microbiol.* 134:2213-29.
- Klečka, G.M., and S.J. Gonsior. 1986. Removal of 1,4-dioxane from wastewater. *J. Hazard. Mater.* 13:161-168.
- Kohlweyer, U., B. Thiemer, T. Schrader, and J.R. Andreesen. 2000. Tetrahydrofuran degradation by a newly isolated culture of *Pseudonocardia* sp. strain K1. *FEMS Microbiol. Lett.* 186:301-306.
- Kotani, T., T. Yamamoto, H. Yurimoto, Y. Sakai, and N. Kato. 2003. Propane monooxygenase and NAD⁺-dependent secondary alcohol dehydrogenase in propane metabolism by *Gordonia* sp. strain TY-5. *J. Bacteriol.* 185:7120-8.
- Kotani, T., Y. Kawashima, H. Yurimoto, N. Kato, and Y. Sakai. 2006. Gene structure and regulation of alkane monooxygenases in propane-utilizing *Mycobacterium* sp. TY-6 and *Pseudonocardia* sp. TY-7. *J. Biosci. Bioeng.* 102:184-92.
- Kukor, J.J., R.H. Olsen, and J.S. Siak. 1989. Recruitment of a chromosomally encoded maleylacetate reductase for degradation of 2,4-dichlorophenoxyacetic acid by plasmid pJP4. *J. Bacteriol.* 171:3385-3390.
- Kumar, S., K. Tamura, I.B. Jakobsen, and M. Nei. 2001. MEGA2: molecular evolutionary genetics analysis software. *Bioinformatics* 17:1244-1245.
- Leahy, J.G., P.J. Batchelor, and S.M. Morcomb. 2003. Evolution of the soluble diiron monooxygenases. *FEMS Microbiol. Rev.* 27(4):449-479.

Lesage, S., R.E. Jackson, M.W. Priddle, and P.G. Reimann. 1990. Occurrence and fate of organic solvent residues in anoxic groundwater at the Gloucester Landfill, Canada. *Environ. Sci. Technol.* 24:559-566.

Lorentzen, R. J. et al. 1975. The autoxidation of 6-hydroxybenzo[a]pyrene and 6-oxobenzo[a]-pyrene radical, reactive metabolites of benzo[a]pyrene. *Biochemistry* 14:3970-3977.

Mahendra, S., and L. Alvarez-Cohen. 2005 *Pseudonocardia dioxanivorans* sp. Nov., a novel actinomycete that grows on 1,4-dioxane. *Int. Syst. Evol. Microbiol.* 55:593-598

Mahendra, S., and L. Alvarez-Cohen. 2006. Kinetics of 1,4-dioxane biodegradation by monooxygenase-expressing bacteria. *Environ. Sci. Technol.* 40:5435-5442.

Makino, Y., K. Amada, H. Taguchi, and M. Yoshida. 1997. Chaperonin-mediated folding of green fluorescent protein. *J. Biol. Chem.* 272:12468-74.

McClay, K., B.G. Fox, and R.J. Steffan. 1996. Chloroform mineralization by toluene-oxidizing bacteria. *Appl. Environ. Microbiol.* 62:2716-2722.

McLeod M.P., R.L. Warren, W.W. Hsia, N. Araki, M. Myhre, C. Fernandes, D. Miyazawa, W. Wong, A.L. Lillquist, D. Wang, M. Dosanjh, H. Hara, A. Petrescu, R.D. Morin, G. Yang, J.M. Stott, J.E. Schein, H. Shin, D. Smailus, A.S. Siddiqui, M.A. Marra, S.J. Jones, R. Holt, F.S. Brinkman, K. Miyauchi, M. Fukuda, J.E. Davies, W.W. Mohn, and L.D. Eltis. 2006. The complete genome of *Rhodococcus* sp. RHA1 provides insights into a catabolic powerhouse. *Proc. Natl. Acad. Sci. U. S. A.* 103:15582-7. Epub 2006 Oct 9.

Mermod, N., J.L. Ramos, P.R. Lehrbach, and K.N. Timmis. 1986. Vector for regulated expression of cloned genes in a wide range of gram-negative bacteria. *J. Bacteriol.* 167:447-454.

Miller, V.L., and J.J. Mekalanos. 1988. A novel suicide vector and its use in construction of insertion mutations: osmoregulation of outer membrane proteins and virulence determinants in *Vibrio cholerae* requires toxR. *J. Bacteriol.* 170:2575-83.

Mohr, T.K.G. 2001 Solvent stabilizers white paper. [Online.] Santa Clara Valley Water District, San Jose. Calif.
http://www.valleywater.org/Water/Water_Quality/Protecting_your_water/_Solvents/_PDFs/SolventStabilizers.pdf

Mormile, M.R., S. Liu, and J.M. Suflita. 1994. Anaerobic biodegradation of gasoline oxygenates: extrapolation of information to multiple sites and redox conditions. *Environ. Sci. Technol.* 28:1727-1732.

- Murphy G.L., and J.J. Perry. 1983. Incorporation of chlorinated alkanes into fatty acids of hydrocarbon-utilizing mycobacteria. *J. Bacteriol.* 156:1158-1164
- Nakamiya, K., S. Hashimoto, H. Ito, J.S. Edmonds, and M. Morita. 2005. Degradation of 1,4-dioxane and cyclic ethers by an isolated fungus. *Appl. Environ. Microbiol.* 73:1254-1258.
- Ochman, H, A.S. Gerber, and D.L. Hartl. 1988. Genetic applications of an inverse polymerase chain reaction. *Genetics.* 120:621-623.
- Parales, R.E., J.E. Adamus, N. White, and H.D. May. 1994. Degradation of 1,4-dioxane by an actinomycete in pure culture. *Appl. Environ. Microbiol.* 60:4527-30.
- Priddle, M.W., and R.E. Jackson. 1991. Laboratory column measurement of VOC retardation factors and comparison with field values. *Ground Water* 29:260-266.
- Sielaff B. and J.R. Andreesen. 2005. Analysis of the nearly identical morpholine monooxygenase-encoding *mor* genes from different *Mycobacterium* strains and characterization of the specific NADH : ferredoxin oxidoreductase of this cytochrome P450 system. *Microbiology.* 15:2593-2603.
- Smith, T.J, J.S. Lloyd, S.C. Gallagher, W.L. Fosdike, J.C. Murrell, and H. Dalton. 1999. Heterologous expression of alkene monooxygenase from *Rhodococcus rhodochrous* B-276. *Eur. J. Biochem.* 260:446-452.
- Smits, T.H., M. Rothlisberger, B. Witholt, and J.B. van Beilen. 1999. Molecular screening for alkane hydroxylase genes in Gram-negative and Gram-positive strains. *Environ. Microbiol.* 1:307-317.
- Smits, T.H., S.B. Balada, B. Witholt, and J.B. van Beilen. 2001. Functional analysis of alkane hydroxylases from gram-negative and gram-positive bacteria. *J. Bacteriol.* 184:1733-42.
- Stefan, M.I., and J.R. Bolton. 1998. Mechanism of the degradation of 1,4-dioxane in dilute aqueous solutions using the UV/hydrogen peroxide process. *Environ. Sci. Technol.* 32:1588-1595.
- Steffan, R.J., K. McClay, S. Vainberg, C.W. Condee, and D. Zhang. 1997. Biodegradation of the gasoline oxygenates methyl tert-butyl ether, ethyl tert-butyl ether, and tert-amyl methyl ether by propane-oxidizing bacteria. *Appl. Environ. Microbiol.* 63:4216-4222.
- Steffan, R. J., Y. Farhan, C. W. Condee, and S. Drew. 2003. Bioremediation at a New Jersey Site Using Propane-Oxidizing Bacteria. pp. 503-516. In: Ellen Moyer and Paul Kostecki (eds.), Chapter 27: MTBE Remediation Handbook, Amherst Scientific Publisher, Amherst, MA

- Streger, S.H. C.W. Condee, A.P. Togna, M.F. DeFlaun. 1999. Degradation of hydrohalocarbons and brominated compounds by methane- and propane-oxidizing bacteria. *Environ. Sci. Technol.* 33:4477-4482.
- Suflita, J.M., and M.R. Mormile. 1993. Anaerobic biodegradation of known and potential gasoline oxygenates in the terrestrial subsurface. *Environ. Sci. Technol.* 27:976-978
- Tatusova, T.A., and T.L. Madden. 1999. BLAST 2 Sequences-a new tool for comparing protein and nucleotide sequences, *FEMS Microbiol. Lett.* 174:247-250.
- Thiemer, B., J.R. Andreesen, and T. Schrader. 2001. The NADH-dependent reductase of a putative multicomponent tetrahydrofuran mono-oxygenase contains a covalently bound FAD. *Eur. J. Biochem.* 268:3774-3782.
- Thiemer, B., J.R. Andreesen, and T. Schrader. 2003. Cloning and characterization of a gene cluster involved in tetrahydrofuran degradation in *Pseudonocardia* sp. strain K1. *Arch. Microbiol.* 179:266-277. Epub 2003 Mar 12.
- Vainberg, S., K. McClay, H. Masuda, D. Root, C.W. Condee, G.J. Zylstra, and R.J. Steffan. 2006. Biodegradation of ether pollutants by *Pseudonocardia* sp. strain ENV478. *Appl. Environ. Microbiol.* 72:5218-5224.
- van Beilen, J.B., R. Holtackers, D. Luscher, U. Bauer, B. Witholt, and W.A. Duetz. 2005. Biocatalytic production of perillyl alcohol from limonene by using a novel *Mycobacterium* sp. Cytochrome P450 alkane hydroxylase expressed in *Pseudomonas putida*. *Appl. Environ. Microbiol.* 71:1737-1744.
- White, G.F., N.J. Russell, and E.C. Tidswell. 1996. Bacterial scission of ether bonds. *Microbiol. Rev.* 60:216-232.
- Whited, G.M., and D.T. Gibson. 1991. Toluene-4-monooxygenase, a three-component enzyme system that catalyzes the oxidation of toluene to p-cresol in *Pseudomonas mendocina* KR1. *J. Bacteriol.* 173:3010-3016.
- Whyte, L.G., T.H. Smits, D. Labbe, B. Witholt, C.W. Greer, J.B. and van Beilen. 2002. Gene cloning and characterization of multiple alkane hydroxylase systems in *Rhodococcus* strains Q15 and NRRL B-16531. *Appl. Environ. Microbiol.* 68(12):5933-5942.
- Wilson, J.T., J.S. Cho, B.H. Wilson, and J.A. Vardy. 2000. Natural attenuation of MTBE in the subsurface under methanogenic conditions. EPA/600/R-00/006. U.S. Environmental Protection Agency, Washington, D.C.

Woo, Y.T., J.C. Arcos, M.F. Argus, G.W. Griffin, and K. Nishiyama. 1977. Structural identification of p-dioxane-2-one as the major urinary metabolite of p-dioxane. *Naunyn-Schmiedeberg's Arch. Pharmacol.* 299:283-287.

Yamashita, M., A. Tani, and F. Kawai. 2004. A new ether bond-splitting enzyme found in Gram-positive polyethylene glycol 6000-utilizing bacterium, *Pseudonocardia* sp. strain K1. *Appl. Microbiol. Biotechnol.* 66:174-179. Epub 2004 Oct 12.

Yeh, C.K., and J.T. Novak. 1994. Anaerobic biodegradation of gasoline oxygenates in soils. *Water Environ. Res.* 66:744-752.

Yen, K.M., M.R. Karl, L.M. Blatt, M.J. Simon, R.B. Winter, P.R. Fausset, H.S. Lu, A.A. Harcourt, and K.K. Chen. 1991. Cloning and characterization of a *Pseudomonas mendocina* KR1 gene cluster encoding toluene-4-monooxygenase. *J. Bacteriol.* 173:5315-5327.

Zenker, M.J., R.C. Borden, and M.A. Barlaz. 2000. Mineralization of 1,4-dioxane in the presence of a structural analog. *Biodegradation* 11:239-246.

Appendix 1. PCR Primers Used in This Study

Primer name	Sequence
Degenerate oxygenase probes	
AlkF	5'-aatachgsvcaygagctcrgycayaar-3'
alkR	5'-gertgrtgatcagartghcgytg-3'
PropF	5'-tggttygagaacmastacc-3'
PropR	5'-cggabrtcgtcgvgtcca-3'
450F	5'- gtsggcggcaacgacacsac-3'
450R	5'- gcascggtggatgccgaagccraa-3'
AlkB of ENV421	
alkBF	5'-tgggaggtaaactcatatgacgtctcaactggac-3'
rubA2R	5'-ccgaggaagcttcacatgcgcgagagtagtggtca-3'
PMO operon of ENV425	
425chapR10	5'-accacaagcttgctctagtagatggtggacggg-3'
425chapR11	5'-accacaagcttgctctagtagatggtgg-3'
chapR2	5'-gctagcttgctctagtagatggtgg-3'
chapR1	5'-tscgytccttgagctcgac-3'
ChapF*	5'-gccctcgccgacgcgg-3'
chapR	5'-taattacaagcttgctctagtagatggtggac-3'
chapMidF	5'-gtcggcggcaacatgcacaa-3'
chapMidR	5'-ttgtgcatgttccgcccac-3'
ChapRBS	5'-gagatcaactcatcggaaattctcgtcgg-3'
425midR	5'-tcgaagatggagccgtcgaattcctgacce-3'
425midF	5'-gggtcaggaattcgacggctccatcttca-3'
425AF2	5'-catatcggctcacttcccgatggagg-3'
425AR2	5'-gctagcgcggtggkkggsycg-3'
425AR	5'-gctagctccatgctgatgctgacggg-3'
425 up reverse	5'-tctcgaacgcgatcggcttgtt-3'
425 down	5'-cgcgacgacggcaagacct-3'
425AF3	5'-catatgagtaggcaaagcctgacaaggccca-3'
425MidoperonF	5'-cacatgagcgagaccggca-3'
425MidoperonR5'	5'-gtgaactgtcgtagaagatctggtctttcgg-3'
425DR	5'-acgtggccgtccacgatgaagta-3'
425DR Hind	5'-gtcccagaagcttacgtggccgtccacgatgaagt-3'
425 Sma	5'-ttcgagtgttcgagcacaagtaccggg-3'
PMOxba	5'-tcatctagaaggagacgcacaatgagtaggcaaagcctgacaaa-3'
ThfMO of ENV478	
thmAF	5'-aaacatgaatccgaaagggagaaagattacgatgactgccccacc-3'
thmP1R	5'-gcgaagcttgaatatttcttagat-3'
thmP2F	5'-atatatctaagaaatattcaagct-3'
thmP2R	5'-ccaatggcggcccccacatctcaaggagtgaaaa-3'
thfAF2	5'-atcatctagaagaaggagatatacatatgactgccccaccgatgaag-3'
thfAR2	5'-ttgatatttctgtagctcagaccccgaagagcggcg-3'

sod S R 5'-cataacagtgagttcctcacgctagaac-3'
sodF 5'-catatgtcttcatttcaattgccaaagcttcgatgactatgat-3'
sodR 5'-aagcaattcaatcacaaaaacattag-3'
sodReco 5'-tttgaattctaattgttttggattgaattgctgtaaatactctc
 gtttactcgggccag-3'
sod end 5'-ctaagtgttttggattgaattgctttagatactt
 ctcgtttacgcggccag-3'

Chloroacetylaldehyde dehydrogenase of ENV481

CADpro 5'-ggaacgcgtctggcacggccgctgcaatat-3'
CADr 5'-tccccaatggggagaggaaagctcgtgcct-3'

PMO chaperone from *M smegmatis*

smegChapF 5'-gccctctagaaaggactccgacctggccaaag-3'
smegChapR 5'-ctgtaagaagcttcagtagatgttgacgggcgga-3'
groSF 5'-gtggagggtcccatatggcgagcgtgaacatc-3'
groSR 5'-cggtgaacgctagcgattacttgagacgacagcca-3'

Appendix 2. Vainberg et al., 2006

APPLIED AND ENVIRONMENTAL MICROBIOLOGY, Aug. 2006, p. 5218-5224
0099-2240/06/\$08.00+0 doi:10.1128/AEM.00160-06
Copyright © 2006, American Society for Microbiology. All Rights Reserved.

Vol. 72, No. 8

Biodegradation of Ether Pollutants by *Pseudonocardia* sp. Strain ENV478

Simon Vainberg,¹ Kevin McClay,¹ Hisako Masuda,² Duane Root,³
Charles Condee,¹ Gerben J. Zylstra,² and Robert J. Steffan^{1*}

¹Shaw Environmental, Inc., 17 Princess Rd., Lawrenceville, New Jersey 08648¹; ²Biotechnology Center for
Agriculture and the Environment, Rutgers University, New Brunswick, New Jersey 08901²; and
³Shaw Environmental, Inc., 304 Directors Dr., Knoxville, Tennessee 37923³

Received 20 January 2006/Accepted 22 May 2006

A bacterium designated *Pseudonocardia* sp. strain ENV478 was isolated by enrichment culturing on tetrahydrofuran (THF) and was screened to determine its ability to degrade a range of ether pollutants. After growth on THF, strain ENV478 degraded THF (63 mg/h/g total suspended solids [TSS]), 1,4-dioxane (21 mg/h/g TSS), 1,3-dioxolane (19 mg/h/g TSS), bis-2-chloroethylether (BCEE) (12 mg/h/g TSS), and methyl *tert*-butyl ether (MTBE) (9.1 mg/h/g TSS). Although the highest rates of 1,4-dioxane degradation occurred after growth on THF, strain ENV478 also degraded 1,4-dioxane after growth on sucrose, lactate, yeast extract, 2-propanol, and propane, indicating that there was some level of constitutive degradative activity. The BCEE degradation rates were about threefold higher after growth on propane (32 mg/h/g TSS) than after growth on THF, and MTBE degradation resulted in accumulation of *tert*-butyl alcohol. Degradation of 1,4-dioxane resulted in accumulation of 2-hydroxyethoxyacetic acid (2HEAA). Despite its inability to grow on 1,4-dioxane, strain ENV478 degraded this compound for >80 days in aquifer microcosms. Our results suggest that the inability of strain ENV478 and possibly other THF-degrading bacteria to grow on 1,4-dioxane is related to their inability to efficiently metabolize the 1,4-dioxane degradation product 2HEAA but that strain ENV478 may nonetheless be useful as a biocatalyst for remediating 1,4-dioxane-contaminated aquifers.

Ether-containing organic compounds are widely used as solvents, pesticides, and gasoline additives and in a host of other applications. Very recently, the solvent stabilizer 1,4-dioxane has emerged as an important groundwater contaminant throughout the United States and elsewhere (26). Like many ethers, this compound is miscible in water, has a low dimensionless Henry's Law constant (2.0×10^{-4}), and has a low octanol/water partitioning coefficient (1.23); thus, it is poorly retarded in aquifers and has the potential to create large contaminant plumes that threaten drinking water supplies that are distant from the original release sites (14, 23, 29).

Few treatment methods have proven to be successful and economically feasible for removing 1,4-dioxane from groundwater. Because of the low octanol/water partitioning coefficient and low Henry's Law constant of this compound, traditional remediation technologies like carbon adsorption and air stripping are inefficient and costly. Likewise, *in situ* and *ex situ* biological treatments of 1,4-dioxane have not emerged as viable treatment options even though some microbes have been shown to degrade the compound (3, 5, 12, 18, 23, 27, 28, 43). Only a few *ex situ* technologies, including chemical oxidation with a combination of ozone and hydrogen peroxide (1) or hydrogen peroxide and UV light (32), have been utilized commercially to destroy 1,4-dioxane, but the cost of using these technologies for high-concentration waste streams can be prohibitive.

Relatively few studies have evaluated biological degradation

of 1,4-dioxane, but the indigenous microorganisms at contaminated sites often are not able to degrade this compound (12, 23). In the last several years, however, 1,4-dioxane biodegradation has been reported for both pure (28, 5, 3) and mixed cultures of bacteria (18, 43) and for a fungal isolate (27). For example, a pure culture of the propane-oxidizing bacterium *Mycobacterium vaccae* JOB5 was shown to partially degrade 1,4-dioxane but not to grow on this compound (5). Bernhardt and Diekmann (3) reported biodegradation of 1,4-dioxane by a *Rhodococcus* strain, and Parales et al. (28) isolated a bacterium (strain CB1190) that is capable of sustained growth and mineralization of 1,4-dioxane, albeit at low rates. Strain CB1190 has recently been reclassified as *Pseudonocardia dioxanivorans* strain CB1190 (24). In other studies, mixed cultures of bacteria were able to degrade 1,4-dioxane, but only in the presence of the cosubstrate tetrahydrofuran (THF) (43).

Unlike biodegradation of 1,4-dioxane, biodegradation of the cyclic monoether THF has been well studied, and this compound appears to be a growth substrate for many bacteria (3, 7, 19, 28, 37, 43). Detailed molecular and biochemical analysis of THF degradation by *Pseudonocardia* sp. strain K1 led to cloning of an operon involved in THF degradation and to description of a biodegradation pathway for THF (37). The initial transformation of THF by strain K1 appears to involve a binuclear iron-containing multicomponent THF monooxygenase (THFmo) that oxidizes THF to 2-hydroxytetrahydrofuran (36, 37). The authors also suggested that a dehydrogenase could convert 2-hydroxytetrahydrofuran to γ -butyrolactone, a hydrolase could convert γ -butyrolactone to 4-hydroxybutyrate, and a second dehydrogenase could convert 4-hydroxybutyrate to succinate semialdehyde.

* Corresponding author. Mailing address: Shaw Environmental, Inc., 17 Princess Rd., Lawrenceville, NJ 08648. Phone: (609) 895-5350. Fax: (609) 895-1858. E-mail: Rob.Steffan@shawgrp.com.

Although no bacterial 1,4-dioxane biodegradation pathway has been described, two reports have described 1,4-dioxane degradation in rats. Woo et al. (40) suggested that 1,4-dioxane-2-one (PDX) is the major urinary metabolite of 1,4-dioxane in rats but that there could be other pathways. Braun and Young (4), using a different approach, identified 2-hydroxyethoxyacetic acid (2HEAA) as the major metabolite. δ -Hydroxy acids, however, rarely are present in the pure state or in aqueous solutions except in the form of salts; rather, the majority of these acids are known primarily in the lactone form. Thus, lactonization of 2HEAA would result in production of PDX, as identified in the study of Woo et al. (40). PDX also can polymerize spontaneously to form linear polymers, or it can be reversibly converted to 2HEAA under basic conditions. In a study of 1,4-dioxane degradation by a pure culture of filamentous fungi, ethylene glycol was the first 1,4-dioxane product detected, suggesting that there may be an alternate degradation pathway (27).

In this paper we describe isolation and characterization of a new THF-degrading bacterium, strain ENV478. We evaluated the ability of this strain to degrade ether-containing pollutants and focused on 1,4-dioxane degradation. The initial 1,4-dioxane biodegradation experiments revealed that 2HEAA is produced as an apparent terminal product of 1,4-dioxane degradation in strain ENV478. These results suggest that the inability of strain ENV478 and perhaps other THF-degrading strains to grow on 1,4-dioxane may be related to their inability to efficiently utilize this metabolite.

MATERIALS AND METHODS

Chemicals. 1,4-Dioxane (98%) was purchased from Aldrich Chemical Co. (Milwaukee, WI). R2A medium was obtained from BBL, Inc. (Cockeysville, MD). Unless indicated otherwise, all other chemicals were the highest purity available and were purchased from either Aldrich Chemical Co. (Milwaukee, WI), Mallinckrodt Specialty Chemical Co. (Paris, KY), J. T. Baker Inc. (Phillipsburg, NJ), or Sigma Chemical Co. (St. Louis, MO). Uniformly labeled 1,4- 14 C-dioxane (0.08 mCi/mmol; 96.4% radiochemical purity as determined by high-performance liquid chromatography [HPLC]) was purchased from Sigma (St. Louis, MO).

Isolation and growth of strain ENV478. Strain ENV478 was isolated by enrichment culturing from the liquor of a membrane bioreactor system that was treating a mixture of wastes from a fine chemical manufacturer. Enrichment culturing was performed with THF (100 mg/liter) as the sole carbon source and basal salts medium (BSM) (13). Cultures growing on THF were plated on R2A agar plates (EM Science, Gibbstown, NJ), and individual colonies were screened for the ability to grow on THF as a sole source of carbon and energy. Individual isolates were grown in BSM containing THF, washed, and screened as described below for the ability to degrade 1,4-dioxane. Strain ENV478 was maintained on R2A agar plates or in BSM containing THF. Enrichment culturing of the same reactor liquor with 1,4-dioxane as the sole carbon source did not result in a culture that could grow on 1,4-dioxane.

16S rRNA analysis. Total genomic DNA was isolated from strain ENV478 by using a DNA extraction kit (Clontech, Mountain View, CA). The 16S rRNA genes were PCR amplified with primers 27f and 1522r under conditions recommended by the supplier (Sigma, St. Louis, MO). The purified PCR product (QIAGEN, Valencia, CA) was used directly in DNA sequencing reactions (Applied Biosystems, Foster City, CA) with primers 27f, 357f, 704f, 926f, 1242f, 342r, 685r, 907r, 1392r, and 1522r (15). The complete sequence was assembled and edited with the Lasergene program (DNASTar, Madison, WI). Closely matching sequences were found in the GenBank database using the BLAST algorithm (2), as well as the search function of the Ribosomal Database Project (6). Sequences were aligned using CLUSTALV in the Lasergene software package (DNASTar) and were visually inspected. Phylogenetic analysis was performed with the MEGA version 2.1 software package (20). Distances were determined by maximum parsimony, and bootstrap values were calculated by using 1,000 replications.

Biodegradation assays. Unless indicated otherwise, the cells of strain ENV478 used in biodegradation assays were grown on THF in BSM at 30°C. The cells were collected by centrifugation, washed twice in BSM, and suspended in fresh BSM. Because of the tendency of the cells to clump, cell density was typically determined by measuring total suspended solids (TSS) (39), a measurement of the dry weight of filtered cells. Assays were performed in 60-ml serum vials sealed with Teflon-lined septa and aluminum crimp seals. Killed control samples were poisoned with HgCl₂ (final concentration, 0.1 mM). Ethers were analyzed by using gas chromatography-mass spectrometry (GC-MS) (38) with heated purge and trap.

Synthesis of potential pathway intermediates. Elucidation of the pathway required that we first synthesize the potential degradation products as analytical standards. 2HEAA and PDX were synthesized essentially as described by Doddi et al. (9). This synthesis involved preparation of sodium glycoxyde by reacting excess ethylene glycol with metallic sodium. The glycoxyde was then reacted with chloroacetic acid to obtain the sodium salt of 2HEAA (NaHEA). The synthesis reactions are described by the following equations:

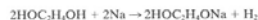

Excess ethylene glycol and reaction by-products were removed by distillation and by washing the residual solid with acetone. The NaHEA was then purified by hot filtering and recrystallization in ethanol-10% water. 2HEAA was prepared in an aqueous solution by eluting a solution of NaHEA through a cation-exchange resin column in the H⁺ form.

PDX was prepared by acidifying NaHEA in ethanol with hydrochloric acid to make 2HEAA and filtering the preparation to remove NaCl. The filtrate containing 2HEAA was distilled at atmospheric pressure over MgCO₃ to remove ethanol and then slowly heated to distill off product, and the fraction boiling at approximately 200°C was collected.

The sodium glycoxyde and chloroacetic acid synthesis procedure produced NaHEA with a yield of purified product of approximately 60%. The identity of the product was verified by GC-MS analysis of the methyl ester derivative of NaHEA, using the method described by Braun and Young (4). This produced a characteristic [M-18] response peak at *m/e* 116 and additional peaks at *m/e* 75, 87, and 103.

The PDX preparation procedure produced a viscous colorless liquid that slowly solidified to a wax after standing. The identity of PDX was verified by direct GC-MS analysis in methylene chloride extracts. The GC-MS chromatogram peak produced a primary [M] response at *m/e* 102 and additional peaks at *m/e* 58 and 73.

Identification of 1,4- 14 C-dioxane degradation products. Ten-milliliter subsamples of a THF-grown ENV478 culture were added to 60-ml serum vials that were sealed with Teflon-lined septa. Ten microliters of a 50:50 mixture of methanol and 14 C-dioxane (0.47 μ Ci) was injected into the vials along with 2 μ l of neat THF. The THF was included to ensure that all of the THF degradation genes were induced. The disappearance of 1,4-dioxane was monitored by injecting 1 μ l of a sample into a Varian 3400 gas chromatograph (Varian, Walnut Creek, Calif.) equipped with a 30-m capillary Vocol column (Supelco, Inc., Bellefonte, Pa.) and a flame ionization detector. The injector and detector temperatures were maintained at 180 and 220°C, respectively, whereas the column temperature was programmed to increase from 85°C to 140°C at a rate of 50°C/min. When ~80% of the dioxane had been degraded, an HPLC analysis was performed to monitor the disappearance of 1,4-dioxane and the appearance of biodegradation metabolites. To prepare the samples for analysis, 500 μ l of sample was placed in a microcentrifuge tube and centrifuged for 5 min at 14,000 rpm (16,000 \times g) to remove the cellular material. The supernatant was then transferred to a 1-ml autosampler vial, which was sealed with a Teflon septum. The metabolites were resolved with a Restek Ultra Aqueous C₁₈ column (3.2 by 150 mm; Restek, Bellefonte, PA) and an isocratic mixture of methanol and water (5:95) at a flow rate of 0.4 ml/min. Elution of the metabolites from the column was monitored at a wavelength of 210 nm. The HPLC eluant was divided into fractions (5- to 30-s intervals) by collecting the eluant in scintillation vials pre-filled with 3 ml of scintillation cocktail so that the amount of radioactivity in each fraction and the total radioactivity in the supernatant could be determined. The elution order of the metabolites was determined by spiking authentic standards with radiolabeled products.

Microcosm studies. Soil and groundwater samples were collected by Solutions-IES (Raleigh, NC) from a 1,4-dioxane-contaminated aquifer located near Elkton, MD. Soil core samples were recovered from the saturated zone of

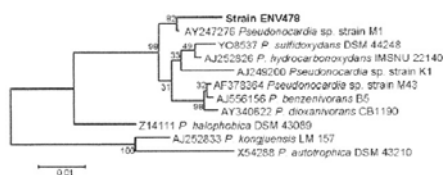

FIG. 1. Dendrogram showing the phylogenetic relationship of strain ENV478 to closely related *Pseudonocardia* strains. The GenBank accession number, genus, species (if known), and strain designation are indicated for each 16S rRNA sequence. The 16S rRNA sequences used for *P. autotrophica*, *P. benzenivorans*, *P. dioxanivorans*, *P. halophobica*, *P. hydrocarbonoxydans*, *P. kongjuensis*, and *P. sulfidoxydans* are the sequences of the type strains of the species (10, 17, 24, 25, 21, 22, 30). Strains M1, K1, and M43 have not been assigned to species (7, 19). The bootstrap values at the nodes indicate the percentages of occurrence in 1,000 bootstrapped trees. Bar, genetic distance of 0.01.

the aquifer from 2.4 to 3.6 m below the surface by using direct push technology. The core sample was cut to fit in a cooler, and the ends of the core sections were sealed. Three liters of groundwater was collected by using a peristaltic pump and stored in sterile glass jars. All samples were placed on ice and shipped via overnight courier to our laboratory. Soil samples were extruded from the cores, combined, and mixed in an anaerobic chamber, and then they were passed through a 6.4-mm sieve to remove stones. Microcosms were constructed in triplicate 160-ml serum vials, and they received 40 g of soil and 80 ml of groundwater. Control microcosms received no amendments. Killed samples received 1 ml of 3.6% HgCl_2 , and augmented samples received 1 ml of washed THF-grown ENV478 (optical density at 550 nm, 16). The microcosms were sealed with Teflon-lined septa and aluminum crimp seals, and 20 ml of oxygen was injected into each microcosm headspace. The microcosms were placed on their sides and incubated at 15°C on an orbital shaker (120 rpm) in the dark. For sampling, the microcosms were shaken vigorously and the soil was allowed to settle before 1 to 5 ml of the aqueous fraction was removed with a syringe and analyzed by GC-MS as described above. In addition to 1,4-dioxane (~100 $\mu\text{g/liter}$), the microcosms contained *cis*-1,2-dichloroethene (110 $\mu\text{g/liter}$), 1,1-dichloroethane (74 $\mu\text{g/liter}$), 1,1,1-trichloroethane (600 $\mu\text{g/liter}$), and trichloroethene (200 $\mu\text{g/liter}$), and they had a total organic carbon content of 1.2 mg/liter.

Nucleotide sequence accession number. The strain ENV478 16S rRNA sequence has been deposited in the GenBank database under accession number DQ437530.

RESULTS

Strain ENV478. Enrichment culturing of an industrial wastewater treatment system resulted in isolation of several bacterial isolates that could grow on THF as the sole carbon and energy source. None of the organisms isolated, however, were able to grow on 1,4-dioxane. One isolate was selected for further study and was designated strain ENV478. Analysis of the 16S rRNA gene sequence of this strain indicated that it is a member of the genus *Pseudonocardia* and clusters with *Pseudonocardia benzenivorans*, *Pseudonocardia dioxanivorans*, *Pseudonocardia hydrocarbonoxydans*, and *Pseudonocardia sulfidoxydans* (Fig. 1). The ability to degrade tetrahydrofuran is well known in this cluster; strains M1, K1, and CB1190 all have this characteristic (7, 19, 24). Given the 16S rRNA sequence distances between *P. benzenivorans*, *P. dioxanivorans*, *P. hydrocarbonoxydans*, and *P. sulfidoxydans* and the sequence distance between strain ENV478 and these species, strain ENV478 is probably a member of a new *Pseudonocardia* species.

When grown on BSM with THF, the strain ENV478 culture produced dense clumps of cells that made accurate sampling

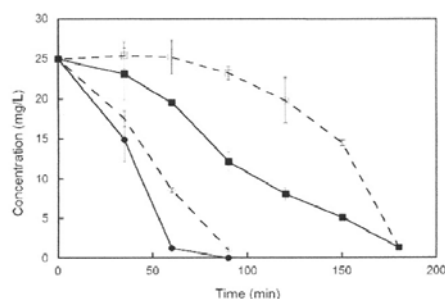

FIG. 2. Biodegradation of 1,4-dioxane (squares) and THF (circles) by strain ENV478 when the compounds were added alone (solid symbols) or as a 50:50 mixture (open symbols). The error bars indicate one standard error of the mean ($n = 3$).

and measurement of optical density difficult. The culture grew readily on BSM with yeast extract and on R2A agar plates. It also grew on lactate, propane, and sucrose, as well as on the following compounds at a concentration of 200 mg/liter each: 1-propanol, 2-propanol, 1-butanol, diethyl ether, diisopropyl ether, propionic acid, butanoic acid, pentanoic acid, and hexanoic acid. It grew on 50 mg/liter octanoic acid but not on 100 or 200 mg/liter octanoic acid. It did not grow on octanol or hexanol, and growth on 1,4-dioxane and 1,3-dioxolane was slight or nonexistent after 30 days of incubation.

Biodegradation of 1,4-dioxane. Following growth on THF, strain ENV478 degraded 1,4-dioxane at an initial rate of approximately 21 mg/h/g TSS, which was approximately one-third the rate at which it degraded THF (63 mg/h/g TSS). When the two substrates were added together at equal concentrations, 1,4-dioxane degradation did not occur until the THF was removed from the medium (Fig. 2). When similarly grown cells were incubated with both 1,4-dioxane and 1,3-dioxolane, they degraded both compounds simultaneously and at approximately the same rate (data not shown). Strain ENV478 also degraded 1,4-dioxane after growth on sucrose (0.71 mg/h/g TSS), yeast extract (1.1 mg/h/g TSS), sodium lactate (0.6 mg/h/g TSS), 2-propanol (1.5 mg/h/g TSS), and propane (3.2 mg/h/g TSS) (Fig. 3), but the 1,4-dioxane degradation rates were much lower than those observed with THF-grown cells (21 mg/h/g TSS). After growth on lactate, the strain also degraded 1,3-dioxolane (1.0 mg/h/g TSS). These findings suggested that strain ENV478 has a low level of constitutive activity with these ethers.

In addition to strain ENV478, for comparison we evaluated 1,4-dioxane degradation by our previously described ether-degrading propanotroph strain ENV425 (34). Strain ENV425 also grew on THF and degraded 1,4-dioxane, but at only one-half the rate (10 mg/h/g TSS) of strain ENV478. Furthermore, whereas strain ENV478 degraded 1,795 mg 1,4-dioxane/g TSS after THF feeding was stopped, strain ENV425 degraded only 200 mg 1,4-dioxane/g TSS.

Analysis of 1,4-dioxane metabolites. Attempts to isolate chemically synthesized 2HEAA from aqueous solutions after

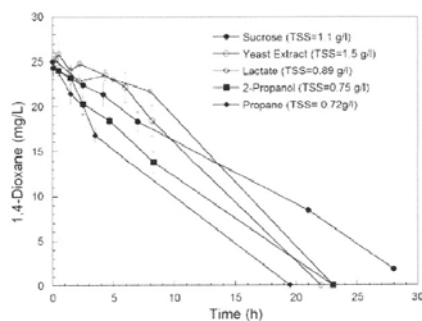

FIG. 3. Biodegradation of 1,4-dioxane by strain ENV478 after growth on different substrates. The initial cell densities (TSS) are indicated. The error bars indicate one standard error of the mean ($n = 3$).

acidification of NaHEA were hampered by apparent conversion of 2HEAA to PDX in a pH-driven equilibrium (4). The equilibrium was driven toward PDX at low pHs in the range from pH 2 to 3, and this was demonstrated by the appearance of PDX in solutions of NaHEA after acidification, as determined by GC-MS analysis of solution extracts. The equilibrium was difficult to monitor because we could not analyze both PDX and HEAA in a single experiment without the potential for interconversion. Direct GC-MS analysis of PDX product solutions revealed only PDX due to our inability to see 2HEAA without derivatization to the methyl ester. Analysis of PDX product solutions for 2HEAA by the methyl ester derivatization method showed that both PDX and 2HEAA were present at a ratio of about 1:4, but the methyl ester 2HEAA derivative may have been formed from PDX during the derivatization process. This made identification and determination of the PDX purity and analysis of PDX in cultures difficult because the derivatization method may result in identification of both compounds as 2HEAA.

To further evaluate the extent of degradation of 1,4-dioxane

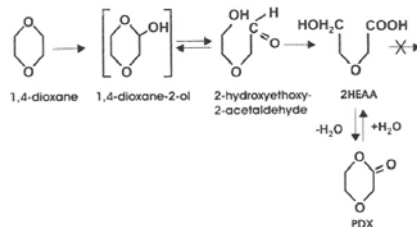

FIG. 4. Proposed partial pathway for biodegradation of 1,4-dioxane by strain ENV478. The 1,4-dioxane-2-ol (hemiacetal) and 2-hydroxyethoxy-2-acetaldehyde were not detectable in the culture media by the methods used in this study. PDX is expected to form spontaneously from 2HEAA under certain conditions (42), but it was not detectable in our experiments.

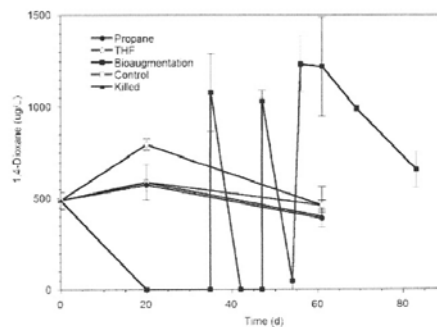

FIG. 5. Biodegradation of 1,4-dioxane in aerobic aquifer microcosms. The different treatments are described in Materials and Methods. "Bioaugmentation" microcosms received THF-grown strain ENV478 (18 mg TSS each). The initial 1,4-dioxane concentration in the site samples was ~500 $\mu\text{g/liter}$, and additional 1,4-dioxane was added to the bioaugmentation microcosms on days 35, 46, and 53. Fresh groundwater was added to the microcosms on day 53, which resulted in 30% dilution of the resident microbial population. The symbols indicate means ($n = 3$), and the error bars indicate standard errors.

by strain ENV478, THF-grown cells were washed and incubated with uniformly labeled 1,4- ^{14}C]dioxane, and an HPLC method that did not require derivatization was developed and employed. Analysis of the culture liquor demonstrated that the ^{14}C]dioxane was converted to a product that coeluted with authentic 2HEAA, but no other potential intermediates (Fig. 4) were detected. The apparent 2HEAA product was not degraded further, even after 402 h of incubation at 25°C. Addition of THF to cultures that had depleted the 1,4-dioxane and accumulated 2HEAA did not result in further degradation of this product. At the end of the experiment, no overall decrease in the radioactivity in the supernatant was observed compared to the radioactivity in the control, indicating that no carbon dioxide had been produced and no 1,4-dioxane was converted to strain ENV478 biomass. In separate growth studies, strain ENV478 was not able to grow on HEAA as a sole carbon source.

Degradation of other ethers. In other degradation experiments with THF-grown strain ENV478, the culture was able to degrade the related solvent 1,3-dioxolane (19 mg/h/g TSS), the gasoline additive methyl *tert*-butyl ether (MTBE) (9.1 mg/h/g TSS), and the plasticizer *bis*-2-chloroethyl ether (BCEE) (12 mg/h/g TSS). Interestingly, the strain degraded 1,4-dioxane faster after growth on THF than after growth on propane, but it degraded BCEE about three times faster after growth on propane than after growth on THF (32 versus 12 mg/h/g TSS). Although the products of BCEE and 1,3-dioxolane degradation were not analyzed, MTBE oxidation resulted in accumulation of *tert*-butyl alcohol that was not degraded further by the strain.

Microcosm studies. To test the utility of THF-degrading strains like strain ENV478 for treating 1,4-dioxane-contaminated aquifers, a microcosm study was conducted with field samples. THF-grown strain ENV478 cells were washed and

added to triplicate microcosms (18 mg TSS/microcosm; final concentration, $\sim 5 \times 10^8$ cells/ml), and the microcosms were incubated aerobically for 80 days at 15°C (Fig. 5). 1,4-Dioxane (~ 700 µg/liter) was rapidly degraded in the augmented microcosms before the first sampling time (day 20), and it was also rapidly degraded after repeated additions ($\sim 1,000$ µg/liter). After 53 days of incubation, fresh groundwater was added to the microcosms to replace the volume that had been removed for sampling. This process resulted in $\sim 30\%$ dilution of the resident microbial population in the microcosms and in a concomitant decrease in 1,4-dioxane degradation. The 1,4-dioxane degradation activity in the microcosms recovered, however, and 1,4-dioxane continued to be degraded, albeit at a slightly lower rate. Little loss of 1,4-dioxane was observed in microcosms that did not receive strain ENV478 and in microcosms poisoned with HgCl₂.

DISCUSSION

Pseudonocardia sp. strains are widely distributed nocardioform actinomycetes that are abundant in many environments and are known to degrade a wide range of pollutants. Strain ENV478 and at least two other *Pseudonocardia* strains have now been shown to degrade the cyclic monoether THF (19, 28) and to cometabolically degrade 1,4-dioxane after growth on THF. *P. dioxanivorans* strain CB1190 (24, 28) was isolated from a THF enrichment and is the only *Pseudonocardia* strain that is known to grow on 1,4-dioxane as a sole carbon source. A related strain, *Pseudonocardia* sp. strain K1 (19), also grows on THF but not 1,4-dioxane and has been studied in detail, which has led to cloning and analysis of an apparent THF oxidation operon.

In this study, we isolated a new organism, strain ENV478, that is phylogenetically related to strains CB1190 and K1 (Fig. 1) but is not able to grow on 1,4-dioxane as a sole carbon source even though it appears that the same enzyme(s) in the strain is required to oxidize both substrates (Fig. 2). In this study we focused on evaluating why this strain cannot grow on 1,4-dioxane and on evaluating the use of this strain to degrade 1,4-dioxane in contaminated environments. The inability of strain ENV478 and other THF degraders to grow on 1,4-dioxane could be related to a number of factors, including the lack of induction of the requisite enzyme(s) by 1,4-dioxane or an inability to efficiently process metabolites for energy production.

THF degradation by *Pseudonocardia* strain K1 is facilitated by a plasmid-borne, NADH-dependent, multicomponent, binuclear iron THF monoxygenase (37). Consequently, growth on THF requires an expenditure of energy (for NADH generation) for the primary oxidation. Degradation of 1,4-dioxane by strain ENV478 was greatest after growth on THF, and the presence of THF inhibited degradation of 1,4-dioxane by this strain (Fig. 2). Furthermore, strain ENV478 appeared to accumulate 2HEAA, an expected product of a monoxygenation reaction with 1,4-dioxane, during 1,4-dioxane degradation. Therefore, we concluded that degradation of 1,4-dioxane and THF by strain ENV478 involves an initial oxidation of the cyclic ether by a monoxygenase that presumably is homologous to the THF monoxygenase of strain K1. Because strain ENV478 also can degrade propane, however, the presence of

a short-chain alkane monoxygenase, some of which are known to oxidize ethers (31, 34), including possibly 1,4-dioxane (5), cannot be completely ruled out. However, the relatively low activity of propane-grown cells (Fig. 3) compared to the activity of THF-grown cells (Fig. 2) suggests that propane monoxygenase is a minor catalyst in this strain. Conversely, an alkane monoxygenase may be more important in BCEE oxidation by strain ENV478 because this organism degraded BCEE faster after growth on propane than after growth on THF.

The initial monoxygenation of 1,4-dioxane likely results in production of 1,4-dioxane-2-ol, the hemiacetal of 2-hydroxyethoxy-2-acetaldehyde (Fig. 4). This compound could be oxidized by an alcohol dehydrogenase, as suggested previously for THF (37), or, because of the inherent instability of hemiacetals in water, could be chemically oxidized through the hydroxylaldehyde intermediate to 2HEAA. Because we observed that 2HEAA accumulated in cultures of *Pseudomonas putida* containing cloned toluene-4-monoxygenase genes and two propanotrophs, ENV421 and ENV425 (34; data not shown), it appears unlikely that production of 2HEAA requires multiple specific enzymatic reactions. More research is needed, however, to confirm this assumption. Although under some circumstances the 2HEAA might form PDX, this product is unlikely to occur in aqueous solutions, especially at the near-neutral pH of our cultures. Our attempts to isolate PDX from our cultures of ENV478 were unsuccessful, and even when we attempted to synthesize this compound in our laboratory, at pH >3 it was difficult to obtain PDX without 2HEAA present. The 1,4-dioxane biodegradation pathway in ENV478 (Fig. 4), therefore, appears to be similar to the 1,4-dioxane metabolic pathway proposed for rats (4).

Interestingly, in 1,4-dioxane biodegradation studies with a pure culture of fungi, Nakamiya et al. (27) observed only ethylene glycol, glycolic acid, and oxalic acid as 1,4-dioxane degradation products. This suggests either that an alternative degradation pathway was present in fungi, that 2HEAA was rapidly degraded to these products by the fungi and was not detected in the analyses performed in the study, or that the derivatization method used in the study did not allow detection of 2HEAA. Degradation of 2HEAA to these products could be facilitated by a dehydrogenase related to the diglycolic acid dehydrogenase of strain K1, which cleaves ether bonds adjacent to terminal carboxyl groups in both short-chain ethers (diglycolic acid) and long-chain polymers (polyethylene glycol) (41). A lack of a similar enzyme activity in ENV478 or a stringent substrate range that does not allow the enzyme to cleave 2HEAA, which may be the case in strain K1, may prevent these strains from metabolizing 2HEAA and result in their inability to grow on 1,4-dioxane. Parales et al. (28) suggested that long-term incubation of their THF-degrading cultures with THF and periodic additions of 1,4-dioxane may have led to a mutation that allowed strain CB1190 to grow on 1,4-dioxane. Our results suggest that such a mutation may have allowed the strain to metabolize 2HEAA, but to our knowledge, CB1190 cultures have never been analyzed for this 1,4-dioxane metabolite or for 2HEAA-metabolizing enzyme activity.

Despite the inability of strain ENV478 to grow on 1,4-dioxane in pure culture, this strain is still an effective biocatalyst, degrading 1,4-dioxane over an extended incubation period

(~80 days) (Fig. 5) in microcosms. The ability of this strain to continue to degrade 1,4-dioxane in microcosms may be due to its ability to utilize other carbon sources in the aquifer material to meet its energy and reductant demands for prolonged 1,4-dioxane degradation. Likewise, other microbes in the microcosms may transform the 2HEAA into products that are more readily used by strain ENV478. More research is needed to assess whether prolonged 1,4-dioxane degradation by strain ENV478 can be supported by exogenous carbon sources and to evaluate the fate of 2HEAA in environmental samples.

The inability of 1,4-dioxane to induce the THFmo homolog genes in strain ENV478 also could limit this strain's ability to grow on 1,4-dioxane by limiting the supply of enzyme needed to continuously process 1,4-dioxane. Expression of THFmo appears to be tightly regulated in strain K1 (37). Northern blot analysis demonstrated that the monoxygenase was produced during growth on THF but not after growth on succinate. Conversely, we demonstrated that strain ENV478 can degrade 1,4-dioxane even after growth on alternative substrates (Fig. 3), albeit at a rate lower than the rate observed for fully induced THF-grown cells. This suggests that the apparent THFmo of strain ENV478 is expressed constitutively and that the activity can be induced to even higher levels during growth on THF. The constitutively expressed enzyme may be enough to support prolonged degradation of 1,4-dioxane under certain conditions in the field, as we observed in our microcosm studies, in which 1,4-dioxane was degraded for >80 days (Fig. 5). The possibility that alternative unidentified inducers were present in the microcosm studies, however, cannot be ruled out (16, 31).

Poor induction of downstream enzymes also might limit the processing of 1,4-dioxane metabolites to support the growth of ENV478 on this compound. Although no genes that are obviously involved in 2HEAA metabolism are apparent in the cloned THF operon of strain K1, this strain does produce a diglycolic acid dehydrogenase that cleaves ether bonds adjacent to terminal carboxyl groups in short-chain ethers (41). The lack of such activity or the inability of 1,4-dioxane or its metabolites to induce this or similar activity in strain ENV478 also could limit 2HEAA metabolism. To test the ability of THF to induce 2HEAA metabolism by ENV478, cultures that had accumulated 2HEAA were fed THF. Although the added THF was readily degraded, no further degradation of 2HEAA was observed (data not shown), indicating that THF and its metabolites probably do not induce the expression of genes necessary for 2HEAA metabolism in strain ENV478. Additional studies are under way to further investigate the presence and induction of potential 2HEAA degradation genes in ENV478.

The ability of strain ENV478 to degrade 1,4-dioxane and other potentially important ether pollutants (BCEE, 1,3-dioxane, and MTBE) warrants evaluation of its usefulness as a biocatalyst for in situ or ex situ treatment systems. In situ bioaugmentation with aerobic microorganisms has shown promise for treating recalcitrant pollutants (8, 11, 33, 35), but the technology has not been broadly accepted by the remediation community. Although the microcosms were inoculated with relatively large amounts of strain ENV478, the results of our microcosm study with strain ENV478 indicate that it may be possible to use this strains or similar strains to treat 1,4-dioxane contamination either in situ or in bioreactor systems.

In studies of similar THF degraders in bioreactors the workers found that relatively large amounts of THF had to be added continuously to the systems to maintain 1,4-dioxane degradation activity (43). The ability of strain ENV478 to maintain 1,4-dioxane degradation activity in microcosms for >80 days without THF was, therefore, surprising and encouraging, but much additional work is needed to demonstrate the utility of such biocatalysts for remediating contaminated aquifers (33).

ACKNOWLEDGMENT

This work was supported by the Strategic Environmental Research and Development Program as part of project CU-1422.

REFERENCES

- Adams, C. D., P. A. Scanlan, and N. D. Secrist. 1994. Oxidation and biodegradability enhancement of 1,4-dioxane using hydrogen peroxide and ozone. *Environ. Sci. Technol.* **28**:1812-1818.
- Altschul, S. F., T. L. Madden, A. A. Schaffer, J. Zhang, Z. Zhang, W. Miller, and D. J. Lipman. 1997. Gapped BLAST and PSI-BLAST: a new generation of protein database search programs. *Nucleic Acids Res.* **25**:3389-3402.
- Bernhardt, D., and H. Diekmann. 1991. Degradation of dioxane, tetrahydrofuran and other cyclic ethers by an environmental *Rhodococcus* strain. *Appl. Microbiol. Biotechnol.* **36**:120-123.
- Braun, W. H., and J. D. Young. 1977. Identification of γ -hydroxyethoxyacetic acid as the major urinary metabolite of 1,4-dioxane in the rat. *Toxicol. Appl. Pharmacol.* **39**:33-38.
- Burback, B. L., and J. J. Perry. 1993. Biodegradation and biotransformation of groundwater pollutant mixtures by *Mycobacterium vaccae*. *Appl. Environ. Microbiol.* **59**:1025-1029.
- Cole, J. R., B. Chai, R. J. Farris, Q. Wang, S. A. Kulam, D. M. Megarrell, G. M. Garrity, and M. Tiedje. 2005. The ribosomal database project (RDP-II): sequences and tools for high-throughput rRNA analysis. *Nucleic Acids Res.* **33**:D294-D296.
- Daye, K. J., J. C. Groff, A. C. Kirpekar, and R. Mazumder. 2003. High efficiency degradation of tetrahydrofuran (THF) using a membrane bioreactor: identification of THF-degrading cultures of *Pseudonocardia* sp. strain M1 and *Rhodococcus ruber* isolate M2. *J. Ind. Microbiol. Biotechnol.* **30**: 705-714.
- DeFlaun, M. F., and R. J. Steffan. 2002. Bioaugmentation, p. 434-442. *In* G. Bitton (ed.), *Encyclopedia of environmental microbiology*. John Wiley & Sons, New York, N.Y.
- Doddi, N., C. Varsfelt, and D. Wasserman. October 1977. Synthetic absorbable surgical devices of poly-dioxanone. U.S. patent 4,052,988.
- Embley, T. M., J. Smida, and E. Stackebrandt. 1988. The phylogeny of mycolate-less wall chemotype IV actinomycetes and description of *Pseudonocardia* fam. nov. *Syst. Appl. Microbiol.* **11**:44-52.
- Fathepure, B. Z., V. K. Elango, H. Singh, and M. A. Bruner. 2005. Bioaugmentation potential of a vinyl chloride-assimilating *Mycobacterium* sp., isolated from a chloroethene-contaminated aquifer. *FEMS Microbiol. Lett.* **248**:227-234.
- Fincher, E. L., and W. J. Payne. 1962. Bacterial utilization of ether glycols. *Appl. Microbiol.* **10**:542-547.
- Harland, W., R. L. Crawford, P. J. Chapman, and S. Dagley. 1975. Metabolic function and properties of 4-hydroxyphenylacetic acid 1-hydroxylase from *Pseudomonas acidovorans*. *J. Bacteriol.* **121**:272-285.
- Jackson, R. E., and V. Dwarakanath. 1999. Chlorinated degrading solvents: physical-chemical properties affecting aquifer contamination and remediation. *Ground Water Monit. Remediation* **19**:102-110.
- Johnson, E. L., C. A. Smith, K. T. O'Reilly, and M. R. Hyman. 2004. Induction of methyl tertiary butyl ether (MTBE)-oxidizing activity in *Mycobacterium vaccae* JOB5 by MTBE. *Appl. Environ. Microbiol.* **70**:1023-1030.
- Johnson, J. L. 1994. Similarity analysis of rRNAs, p. 683-700. *In* P. Gerhardt, R. G. E. Murray, W. A. Wood, and N. R. Krieg (ed.), *Methods for general and molecular bacteriology*. American Society for Microbiology, Washington, D.C.
- Kampfer, P., and R. M. Kroppenstedt. 2004. *Pseudonocardia benzenivorans* sp. nov. *Int. J. Syst. Evol. Microbiol.* **54**:749-751.
- Klečka, G. M., and S. J. Gonstor. 1986. Removal of 1,4-dioxane from wastewater. *J. Hazard. Mater.* **13**:161-168.
- Kohlweyer, U., B. Thieme, T. Schrader, and J. R. Andreesen. 2000. Tetrahydrofuran degradation by a newly isolated culture of *Pseudonocardia* sp. strain K1. *FEMS Microbiol. Lett.* **186**:301-306.
- Kumar, S., K. Tamura, I. B. Jakobsen, and M. Nei. 2001. MEGA2: molecular evolutionary genetics analysis software. *Bioinformatics* **17**:1244-1245.
- Lee, S. D., E. S. Kim, and Y. C. Hah. 2000. Phylogenetic analysis of the genera *Pseudonocardia* and *Actinobispora* based on 16S ribosomal DNA sequences. *FEMS Microbiol. Lett.* **182**:125-129.

22. Lee, S. D., E. S. Kim, K. L. Min, W. Y. Lee, S. O. Kang, and Y. C. Hah. 2001. *Pseudonocardia kongjuensis* sp. nov., isolated from a gold mine cave. *Int. J. Syst. Evol. Microbiol.* **51**:1505–1510.
23. Lesage, S., R. E. Jackson, M. W. Priddle, and P. G. Reimann. 1990. Occurrence and fate of organic solvent residues in anoxic groundwater at the Gloucester Landfill, Canada. *Environ. Sci. Technol.* **24**:559–566.
24. Mahendra, S., and L. Alvarez-Cohen. 2005. *Pseudonocardia dioxanivorans* sp. nov., a novel actinomycete that grows on 1,4-dioxane. *Int. Syst. Evol. Microbiol.* **55**:593–598.
25. McVeigh, H. P., J. Munro, and T. M. Embley. 1994. The phylogenetic position of *Pseudoamycolata halophobica* (Akimov et al. 1989) and a proposal to reclassify it as *Pseudonocardia halophobica*. *Int. J. Syst. Bacteriol.* **44**:300–302.
26. Mohr, T. K. G. 2001. Solvent stabilizers white paper. [Online.] Santa Clara Valley Water District, San Jose, Calif. http://www.valleywater.org/Water/Water_Quality/Protecting_your_water/Solvents_PDFs/SolventStabilizers.pdf.
27. Nakamiya, K., S. Hashimoto, H. Ito, J. Edmonds, and M. Morita. 2005. Degradation of 1,4-dioxane and cyclic ethers by an isolated fungus. *Appl. Environ. Microbiol.* **71**:1254–1258.
28. Parales, R. E., J. E. Adams, N. White, and H. D. May. 1994. Degradation of 1,4-dioxane by an actinomycete in pure cultures. *Appl. Environ. Microbiol.* **60**:4527–4530.
29. Priddle, M. W., and R. E. Jackson. 1991. Laboratory column measurement of VOC retardation factors and comparison with field values. *Ground Water* **29**:260–266.
30. Reichert, K., A. Lipski, S. Pradella, E. Stackebrandt, and K. Altendorf. 1998. *Pseudonocardia ussacharolytica* sp. nov. and *Pseudonocardia sulfidovorans* sp. nov., two new dimethyl disulfide-degrading actinomycetes and emended description of the genus *Pseudonocardia*. *Int. J. Syst. Bacteriol.* **48**:441–449.
31. Smith, C. A., K. T. O'Reilly, and M. R. Hyman. 2003. Characterization of the initial reactions during the cometabolic degradation of methyl *tert*-butyl ether (MTBE) by propane-grown *Mycobacterium vaccae* JOB5. *Appl. Environ. Microbiol.* **69**:796–804.
32. Stefan, M. I., and J. R. Bolton. 1998. Mechanism of the degradation of 1,4-dioxane in dilute aqueous solutions using the UV/hydrogen peroxide process. *Environ. Sci. Technol.* **32**:1588–1595.
33. Stefan, R. J., K. L. Sperry, M. T. Walsh, S. Vainberg, and C. W. Condee. 1999. Field-scale evaluation of in situ bioaugmentation for remediation of chlorinated solvents in groundwater. *Environ. Sci. Technol.* **33**:2771–2781.
34. Stefan, R. J., K. McClay, S. Vainberg, C. W. Condee, and D. Zhang. 1997. Biodegradation of the gasoline oxygenates methyl *tert*-butyl ether, ethyl *tert*-butyl ether, and *tert*-amyl methyl ether by propane-oxidizing bacteria. *Appl. Environ. Microbiol.* **63**:4216–4222.
35. Stefan, R. J., Y. Farhan, C. W. Condee, and S. Drew. 2003. Bioremediation at a New Jersey site using propane-oxidizing bacteria, p. 503–516. *In* E. Moyer and P. Kostecki (ed.), *MTBE remediation handbook*. Amherst Scientific Publisher, Amherst Mass.
36. Thieme, B., J. R. Andreesen, and T. Schrader. 2001. The NADH-dependent reductase of a putative multicomponent tetrahydrofuran mono-oxygenase contains a covalently bound FAD. *Eur. J. Biochem.* **268**:3774–3782.
37. Thieme, B., J. R. Andreesen, and T. Schrader. 2003. Cloning and characterization of a gene cluster involved in tetrahydrofuran degradation in *Pseudonocardia* sp. strain K1. *Arch. Microbiol.* **179**:266–277.
38. U.S. Environmental Protection Agency. 1998. U.S. EPA test methods for evaluating solid waste, physical/chemical methods SW846, 3rd edition, revision 5. U.S. Environmental Protection Agency, Washington, D.C.
39. U.S. Environmental Protection Agency. 1999. U.S. EPA methods and guidance for analysis of water and wastes. Publication EPA-600/4-79-020. U.S. Environmental Protection Agency, Washington, D.C.
40. Woo, Y. T., J. C. Arcos, M. F. Argus, G. W. Griffin, and K. Nishiyama. 1977. Structural identification of p-dioxane-2-one as the major urinary metabolite of p-dioxane. *Naunyn-Schmiedeberg's Arch. Pharmacol.* **299**:283–287.
41. Yamashita, M., A. Tani, and F. Kawai. 2005. A new ether bond-splitting enzyme found in gram-positive polyethylene glycol 6000-utilizing bacterium, *Pseudonocardia* sp. *Appl. Microbiol. Biotechnol.* **66**:174–179.
42. Young, J. D., W. H. Braun, and P. J. Gehring. 1978. The dose-dependent fate of 1,4-dioxane in rats. *J. Environ. Pathol. Toxicol.* **2**:263–282.
43. Zenker, M. J., R. C. Borden, and M. A. Barlaz. 2000. Mineralization of 1,4-dioxane in the presence of a structural analog. *Biodegradation* **11**:239–246.

Appendix 3. McClay et al., submitted to Appl. Environ. Microbiol.

Biodegradation of *Bis* (2-chloroethyl) Ether (BCEE)

Kevin McClay, Charles E. Schaefer, Simon Vainberg, Robert J. Steffan*

Shaw Environmental, Inc., Lawrenceville, New Jersey, USA

Running title: Biodegradation of BCEE

*Corresponding author:

Shaw Environmental, Inc., 17 Princess Rd. Lawrenceville, NJ 08648. Tel. (609) 895-5350; fax. (608) 895-1858; E-mail rob.steffan@shawgrp.com.

Abstract

Degradation of *bis* (2-chloroethyl) ether (BCEE) was observed in two bacterial strains. Strain ENV481, a *Xanthobacter* sp., was isolated by enrichment culturing of samples from a Superfund site located in the northeastern United States. The strain was able to grow on BCEE and 2-chloroethylethyl ether as sole sources of carbon and energy. BCEE degradation in strain ENV481 was facilitated by sequential dehalogenation reactions resulting in the formation of 2-(2-chloroethoxy)-ethanol (2CEE) and diethylene glycol (DEG), respectively. 2-hydroxyethoxyacetic acid (2HEAA) was detected as a product of DEG degradation by the strain. Degradation of BCEE by strain ENV481 was independent of oxygen, and the strain was not able to grow on a mixture of benzene, ethylbenzene, toluene and xylenes (BTEX); other prevalent contaminants at the site. Another bacterial isolate, *Pseudonocardia* sp. strain ENV478 (Vainberg et al., 2006. *Appl. Environ. Microbiol.* 72:5218-5224), degraded BCEE after growth on tetrahydrofuran or propane, but was not able to grow on BCEE as a sole carbon source. BCEE degradation by strain ENV478 appeared to be facilitated by a monooxygenase-mediated O-dealkylation mechanism, and it resulted in the accumulation of 2-chloroacetic acid that was only slowly degraded by the strain.

Introduction

Ether-containing aliphatic compounds have been used widely in an array of industrial and agricultural applications, and in many cases they have become important environmental pollutants. Among the ether-containing compounds that have received recurring attention is *bis* (2-chloroethyl) ether (BCEE). BCEE has been used commercially as a solvent for fats and greases, a cleaning fluid for textiles, a constituent of paints and varnishes, and as an insecticide. Most recently, it has been used as a chemical intermediate in the production of a commercial fungicide, and may be present in trace amounts in the final product (2). It also has been identified in leachate and ground water at several former industrial landfills, and it has been speculated that BCEE is generated as a chlorination by-product in waste streams containing ethylene or propylene (29). It has been classified as a probable human carcinogen by the US EPA, with a 10^{-6} cancer risk at a water concentration of $0.03 \mu\text{g/L}$ (21) and consequently the USEPA Region III has established a risk-based concentration for BCEE in tap water of only $9.6 \times 10^{-3} \mu\text{g/L}$ (22). These relatively low regulatory concentrations have created renewed concern about potential sources, transport, and fate of this compound in the environment.

Concern over the release of BCEE to the environment is exacerbated by its mobility and persistence. It has an aqueous solubility of approximately $17,000 \text{ mg/L}$, a $\log K_{oc}$ value of 1.2, and a Henry's Law constant of $1.8 \times 10^{-5} \text{ atm}\cdot\text{m}^3/\text{mole}$ (23). It also is chemically stable and not readily degraded by abiotic mechanisms. These properties limit the natural attenuation (e.g., sorption, volatilization) of BCEE in groundwater and facilitate its migration, and they limit the effectiveness of conventional groundwater remediation technologies such as carbon adsorption and air stripping (4).

Biological degradation is a potential treatment alternative for remediating ether-contaminated environments (18, 19, 25, 26). Mechanisms for biological ether scission have been reviewed in detail (28). The most common scission mechanisms for short-chain alkyl ethers is O-dealkylation whereby a carbon adjacent to the ether bond is hydroxylated forming a hemiacetal. Because hemiacetals are unstable in aqueous solutions, they disproportionate to an alcohol and an aldehyde. In some cases, however, enzymatic reactions may facilitate transformation of the hemiacetal (16). An O-dealkylation mechanism has been suggested for BCEE degradation by a *Rhodococcus* strain (9), and *Rhodococcus* strain DTB (11). In the case of chlorinated ethers like BCEE, however, additional biological reactions may be required prior to ether scission. For example, Janssen and colleagues (6) implicated a dehalogenase reaction in degradation of BCEE by bacterial strain GJ70. Although a complete degradation pathway for BCEE was not proposed, the results suggested that dehalogenation preceded ether scission in this strain. The dechlorinated product (presumably 2-(2-chloroethoxy)-ethanol [2CEE]) could then either 1) undergo ether scission; 2) be further oxidized to the carboxylic acid ether (e.g., 2-(2-chloroethoxy) acetic acid) prior to scission as occurs with 2-chlorovinylether in *Ancyclobacter* strains(26); or, 3) be dehalogenated again to diethylene glycol (DEG) which ultimately undergoes scission.

In this report we describe the isolation of a new BCEE-degrading bacterium, strain ENV481, and we perform a detailed analysis of BCEE degradation products in this strain. We also evaluate BCEE degradation by tetrahydrofuran-degrading *Pseudonocardia* sp. strain ENV478 (24). Our results demonstrate that BCEE can be used by strain ENV481 as a sole source of carbon and energy, and that the strain performs sequential

dehalogenations of BCEE leading to the production of DEG that is then oxidized to 2-hydroxyethoxyacetic acid (2HEAA) and utilized by the strain. Conversely, strain ENV748 appears to oxidize BCEE directly to a hemiacetal that disproportionates to 2-chloroethanol and, presumably, 2-chloroacetaldehyde. The results demonstrate the importance of multiple enzymatic processes, including dehalogenation and oxidative ether scission, in the degradation of BCEE, and they suggest that biological treatment may be a viable remedial alternative for treating BCEE-contaminated environments.

Materials and Methods

Chemicals. *Bis* (2-chloroethyl) ether was 99% grade and purchased from Aldrich Chemical Co. (Milwaukee, WI). 2-hydroxyethoxyacetic acid (2HEAA) was synthesized as previously described (26). R2A medium was from BBL, Inc. (Cockeysville, MD). Unless otherwise stated, all other chemicals were of at least reagent grade and purchased from either Aldrich Chemical Co. (Milwaukee, WI), Mallinckrodt Specialty Chemical Co. (Paris, KY), J.T. Baker Inc. (Phillipsburg, NJ.), or Sigma Chemical Co. (St. Louis, MO).

Isolation and Characterization of a BCEE-Degrading Bacterium. A microcosm study was performed with aquifer soil and groundwater collected from a Superfund landfill site located in southern New Jersey. Approximately 5 ml of microcosm slurry was removed from one of the microcosms and added to 50 ml of basal salts medium (BSM) (3). Four consecutive 1:10 dilutions were made from this medium with the addition of 25 mg/L (0.17 mM) BCEE. After depletion of BCEE the primary enrichment cultures were sub-cultured twice in BSM with 100 mg/l (0.70 mM) of BCEE, and then

plated onto R2A agar plates. Individual colonies were selected and screened for their ability to grow on BCEE, and a single pure culture was selected for further study and designated strain ENV481. Strain ENV481 was characterized by 500 base pair 16S rDNA sequencing performed by a commercial laboratory (Accugenix[®], Newark, DE), and then again by sequencing 1412 bases of 16S rDNA. A BLAST search of the Genbank database with the latter sequence was performed to identify sequences most closely related to that of strain ENV478.

Bacterial Growth. Strain ENV481 was grown in 250- ml flasks with 100 ml of sterile BSM media. Flasks were closed with silicone stoppers and 50 ml of oxygen was added to each flask through a sterile 0.2 μm Nylon filter (Nalgene, Rochester, NY). Flasks were incubated with shaking (250 rpm) at 28 ± 1 °C. Growth substrates, except 2-chloroacetaldehyde, were added to flasks at an initial concentration 100-200 mg/l and then periodically after the growth was observed and substrates were metabolized. 2-chloroacetaldehyde was added at a concentration of 25 mg/l. Cell growth was monitored by measuring optical density of the culture at 550nm (OD_{550}) in a 1 cm cuvette (Spectronic Instruments, Rochester, NY). Strain ENV478 was grown on THF or propane as previously described (24). Growth rates and the doubling time were measured by calculating the bacterial concentration (as dry weight) during the exponential growth phase. Yield was determined by measuring the difference between initial and final bacterial concentration (dry weight) and the amount of substrate utilized. The dry weight of bacterial suspensions was determined gravimetrically after drying washed cells at 105 °C.

Determination of the degradation kinetics and products. Strain ENV481 was grown on BSM medium amended with BCEE, 2-(2-chloroethoxy)-ethanol (2CEE) or diethylene glycol (DEG) as described above. After growth the cells were concentrated by centrifugation and washed three times in chloride free BSM. An equivalent amount of nitrogen in the medium was supplied by adding $(\text{NH}_4)_2\text{SO}_4$ instead of NH_4Cl . The final OD_{550} of bacterial suspensions were 0.65 (growth on BCEE), 1.65 (growth on 2CEE) and 0.66 (growth on DEG). The washed culture (20 mL) was added to 160- ml serum vials and the vials were closed with Teflon-lined septa and aluminum crimp seals. BCEE, 2CEE or DEG were added to a final concentration of 100 mg/l. After defined periods of time samples of the culture liquor from each set of vials were collected, centrifuged to remove cells, filtered through 0.25 μM Nylon filter units and analyzed for BCEE, chloride, and possible products of BCEE degradation (see below). All experiments were performed in duplicate.

Anaerobic degradation of BCEE by strain ENV481. Strain ENV481 was grown in 200 ml of LB medium supplemented with 70 μl of DEG in a 0.5 liter flask. The cells were harvested via centrifugation, rinsed three times with chloride free BSM medium and suspended to an OD_{550} of 1. The washed culture was placed in a 150-ml serum vial and sealed with Teflon lined butyl rubber septa. The vial was then purged with oxygen free nitrogen (flow= 1 liter per minute) for 30 minutes, using a long syringe needle as the inlet and a short needle as the outlet, so that the incoming nitrogen would bubble up through the suspension. The purged vial was transferred to an anaerobic chamber for all

subsequent handling. 5 ml of the culture was collected and analyzed for oxygen content using a CHEMets 0-1 ppm dissolved oxygen kit (Chemetrics Inc., Calverton, VA), revealing that the dissolved oxygen content was <0.1 mg/L. 40-ml subsamples of the culture were transferred in triplicate to sterile 150-ml vials that were subsequently sealed using Teflon lined septa. BCEE was then added to the samples to a final concentration of prior 250 μ M, and the samples were incubated without shaking for 20 hours at room temperature (\sim 25 $^{\circ}$ C). Samples were withdrawn through the septa for GC analysis and ion exchange chromatography as described below. The first samples were taken after 10 minutes of incubation.

Determining the products of BCEE degradation by strain ENV478. *Pseudonocardia* sp. strain ENV478 (24) was grown initially in 500-ml flasks in 200 ml BSM medium containing 0.2% (w/v) yeast extract. After two days of growth the cultures were fed THF (100 mg/L) or propane (1:5 v/v in the headspace). After several additions of THF or propane the cultures were concentrated by centrifugation, and the cell pellets were washed and suspended in BSM medium to a dry weight of 0.5 to 0.7 g/L. 200 mL of cell suspension was added to 500-mL bottles fitted with Teflon-lined caps and lure lock fittings, and BCEE was added to each vial to a final concentration of 100 mg/l (0.70 mM). The samples were incubated with shaking at 28 $^{\circ}$ C, and subsamples were removed periodically, filtered through 0.25 μ m filters, and analyzed for BCEE and potential degradation products.

Analytical methods.

Whenever possible, analytical methods performed during this project followed USEPA SW-846 methods that are available online at <http://www.epa.gov/epaoswer/hazwaste/test/index.htm>. The specific test methods used are identified herein by their USEPA method number. Samples for chemical analysis were filtered through a 0.25µm syringe-mounted nylon filters to remove bacterial cells, and 1 µl of sample was directly injected onto the GC by using an autosampler as described below. The recovery efficiency of this method for each compound analyzed was not measured, but each experiment was performed with replicate samples containing killed cells and/or cell-free medium to account for any analytical deficiencies. BCEE and its breakdown products 2CEE, DEG and ethylene glycol were analyzed on a Varian 3800 GC equipped with an FID detector essentially as described by USEPA method 8015B. A Restek Stabilwax column (diameter 0.53mm, length 30 meters and 1.00µm film thickness; Bellefonte, PA) was set at 50°C for two minutes and was then ramped to 200 °C at 8°C/min and held for 4.25 min for a total run time of 25 minutes. A 1.0 ul splitless injection was made onto the column using a Varian CP-8400 autosampler. The injector temperature was set to 200°C and the FID detector to 250°C. Gas flow rates were set as follows: column flow 5.0 ml/min.; make up gas -25 ml/min; air 200 ml/min; and, hydrogen 30 ml/min. Helium was used for both the column and makeup gas. Results were compared to a 5 point standard curve prepared with authentic compounds. In addition, a colorimetric assay that used Purpald reagent (Sigma-Aldrich, St. Louis, MO) was used for detecting aldehydes in bacteria free medium (12). Analysis of volatile fatty acids, 2-chloroacetic acid, 2-hydroxyethoxyacetic acid (2HEAA), and chloride, was

performed on an ion chromatograph (Dionex Co., Sunnyvale, CA) and USEPA method 9056A.

Results

Isolation and characterization of strain ENV481. Enrichment culturing of microcosm samples with BCEE as a sole source of carbon and energy resulted in the isolation of a single bacterial culture capable of growth on BCEE. The Gram negative isolate formed yellow-green colonies on R2A medium, and the sequenced 1412 bases of 16S rDNA (Genbank accession # EF592179) had 100% identity with *Xanthobacter flavus* strain JW/KR-1 that was isolated from the rhizosphere of rice plants (13). The strain was designated *Xanthobacter* sp. strain ENV481. Strain ENV481 grew on BCEE (Fig. 1), 2-chloroethylethylether, 2-chloroethanol, 2-chloroacetaldehyde, 2-chloroacetic acid (Table 1), 2-propanol, ethanol, L-alanine, sodium lactate, R2A medium, and yeast extract. The strain did not grow on MTBE, diethyl ether, tetrahydrofuran, 1,4-dioxane, 1,1,1-trichloroethane (1,1,1-TCA), 1,1-dichloroethane (1,1-DCA), 1,2-dichloroethane (1,2-DCA), glucose, sucrose, L-histidine, DL-phenylalanine or a mixture of benzene, toluene, ethyl benzene and xylenes (BTEX).

Biodegradation of BCEE by strain ENV481. BCEE-grown strain ENV481 degraded BCEE at an initial rate of approximately $2.4 \pm 0.06 \text{ mM h}^{-1} \text{ g dwt}^{-1}$, and was able to

degrade BCEE at initial concentrations of at least 173 mg/L (1.2 mM) without apparent inhibition. BCEE degradation resulted in the formation of stoichiometric amounts of 2CEE and chloride ions (Figure 2A). Likewise, lactate-grown strain ENV481 degraded BCEE at an initial rate of $2.3 \pm 0.2 \text{ mM h}^{-1} \text{ g dwt}^{-1}$ without an apparent lag period, suggesting constitutive expression of the degradative genes involved in the initial reaction. The addition of relatively high concentrations of BTEX (100 mg/L) neither inhibited nor enhanced BCEE degradation by the strain, and BTEX was not degraded in BCEE grown cultures. Strain ENV481 degraded 2CEE at the rate of $0.83 \pm 0.03 \text{ mM h}^{-1} \text{ g dwt}^{-1}$, and produced stoichiometric amounts of chloride ion. Stoichiometric amounts of DEG did not accumulate during degradation of 2CEE, presumably because DEG was degraded at a greater rate ($1.1 \pm 0.06 \text{ mM h}^{-1} \text{ g dwt}^{-1}$) than the former compound. Ethylene glycol was not detected as a product of DEG degradation, but a transient accumulation of 2HEAA was observed.

To further evaluate the BCEE degradation pathway in strain ENV481, the culture was incubated with a number of potential degradation products. The strain grew well on 2CEE and DEG (Table 1) which are possible pre-scission degradation products (see below). It also grew on 2-chloroethanol and 2-chloroacetic acid (Table 1) which were potential post-scission degradation products (see below), and it was able to degrade 2-chloroacetaldehyde. Growth on 2-chloroacetaldehyde was not confirmed because of the apparent toxicity of this compound at the concentrations typically used for growth studies. The strain also grew on 2HEAA which is a potential pre-scission degradation product, and known to accumulate during monooxygenase-mediated degradation of 1,4-dioxane (24). The strain did not grow in liquid cultures on 100 or 200 mg/L diglycolic acid. No

potential chlorinated ether scission products, e.g., chloroethanol and chloroacetaldehyde, were detected in the culture liquor of cells fed either BCEE or 2CEE.

Dechlorination of BCEE to 2CEE and chloride, followed by dechlorination of 2CEE was modeled using Monod kinetics (14) as follows:

$$\frac{dC_{BCEE}}{dt} = -\frac{q_{BCEE}XC_{BCEE}}{C_{BCEE} + K_{BCEE}} \quad (1)$$

$$\frac{dC_{2CEE}}{dt} = \frac{dC_{BCEE}}{dt} - \frac{q_{2CEE}XC_{2CEE}}{C_{2CEE} + K_{2CEE}} \quad (2)$$

$$\frac{dC_{Cl}}{dt} = 2\frac{dC_{BCEE}}{dt} + \frac{dC_{2CEE}}{dt} \quad (3)$$

$$\frac{dX}{dt} = \mu X \left[\frac{C_{BCEE}}{C_{BCEE} + K_{BCEE}} + \frac{C_{2CEE}}{C_{2CEE} + K_{2CEE}} \right] \quad (4)$$

where C_i is the aqueous concentration of compound i (where i is either BCEE, 2CEE, or chloride) [mmol/L]; t is time [hr], K_i is the concentration of substrate i at which half the maximum utilization rate of compound i is achieved (i.e., half velocity coefficient of compound i) [mmole/L], q_i is the maximum utilization rate of compound i [mmol/g dwt/hr], X is the ENV481 cell concentration [g dwt/L], μ is the ENV481 maximum growth rate constant [hr^{-1}].

The kinetic model assumes that oxygen is present in excess, and that there is no competitive inhibition between BCEE and 2CEE; this latter assumption was verified in

parallel experiments where BCEE degradation was not impacted by addition of equimolar concentrations of 2CEE. The ENV481 maximum growth rate constant (μ) was determined independently in the batch bacterial growth experiments, and initial values of X were measured.

Equations 1 through 4 were simultaneously regressed to the microcosm experimental data in which sequential BCEE and 2CEE degradation and strain ENV481 concentration was measured. Regression to the experimental data was performed using the Microsoft Excel[®] Solver function and a nonlinear least-squares analysis similar to that described by Smith et al. (17).

Regressed values of q and K for BCEE and 2CEE are listed in Table 1. Regression results show that the experimental results are reasonably described by the model, with a correlation coefficient (R^2) of 0.92. Regression results also show that the maximum utilization rate for BCEE is approximately 10-times that of 2CEE, indicating that BCEE was more readily biodegradable than 2CEE for the conditions of this study.

To evaluate the possible role of a monooxygenase enzyme, or the lack of a monooxygenase activity, in BCEE degradation by ENV481, the strain was incubated anaerobically with BCEE. The culture rapidly degraded BCEE under anaerobic conditions (Figure 3). BCEE degradation resulted in the sequential production of stoichiometric amounts of 2CEE and chloride ions, even in the absence of oxygen. These results indicated that an oxygenase enzyme was not responsible for the initial transformations of BCEE.

BCEE Degradation by *Pseudonocardia* sp. strain ENV478. Strain ENV478 was shown previously to degrade BCEE after growth on THF or propane (24), but it did not grow on BCEE as a sole carbon source. Analysis of culture medium of THF or propane grown cells incubated with BCEE revealed the presence of 2-chloroethanol and 2-chloroacetic acid (Figure 4). 2-chloroacetaldehyde was not detected in the culture medium, possibly because it was rapidly oxidized to 2-chloroacetic acid and/or because of the higher analytical detection limit for this catabolite. The strain also degraded BCEE after growth on lactate, but at a slower rate than after growth on THF (data not shown). Constitutive low-level monooxygenase activity in strain ENV478 has been demonstrated (24).

Discussion

BCEE-contaminated groundwater was identified in and around two large landfill Superfund sites in the northeastern United States. In microcosm studies with samples from one of these sites, we observed significant decreases in BCEE concentrations in aerobic microcosms, but only after most of the other contaminants in the samples, especially BTEX, had been biodegraded (unpublished results). Enrichment culturing of the aerobic microcosm samples with BCEE as a sole carbon source led to the isolation of strain ENV481.

Strain ENV481 grew readily on BCEE as a sole carbon and energy source, and it also grew on several potential BCEE degradation products including, 2CEE, DEG, 2HEAA, 2-chloroethanol, 2-chloroacetaldehyde and 2-chloroacetic acid (Table 1).

Phylogenetic analysis of the isolate, based on 16S rDNA sequencing, suggested that it was most closely related to members of the genus *Xanthobacter*. Some *Xanthobacter* strains have been shown to grow on short chain chlorinated aliphatic compounds and to dehalogenate some chlorinated ethers including BCEE (7). The most studied of these strains is *Xanthobacter autotrophicus* strain GJ10 that was isolated in Europe more than 20 years ago (7). Strain GJ10 produces at least two broad substrate hydrolytic dehalogenase enzymes and it also is able to grow aerobically on 1,2-dichloroethane (1,2-DCA) (6). Strain ENV481 does not grow on 1,2-DCA, but it can grow on or degrade the 1,2-DCA degradation products, 2-chloroethanol, 2-chloroacetaldehyde and 2-chloroacetic acid.

At least 4 different BCEE biodegradation pathways were possible in strain ENV481 based on previous studies with related compounds and bacterial strains. The first was O-dealkylation during which monooxygenation of an α -carbon is followed by hemiacetal decomposition (5, 11, 16, 19, 24, 28). This mechanism was proposed for BCEE degradation in *Rhodococcus* sp. strain DEE5151 (9) and *Rhodococcus* sp. strain DBT (11), but it was not fully demonstrated. With BCEE, O-dealkylation would lead to the production of 2-chloroethanol and 2-chloroacetaldehyde. Although strain ENV481 was able to grow on or degrade both of these potential catabolites, these products were not detected in cultures fed BCEE. Likewise, the strain was not able to degrade non-chlorinated ethers including MTBE, diethyl ether, tetrahydrofuran, or 1,4-dioxane which are reported to be degraded by broad substrate monooxygenases via O-dealkylation mechanisms (1, 5, 19, 20, 24). These results suggested that strain ENV481 uses a different, non-monooxygenase, pathway for BCEE degradation, an observation

supported by the fact that strain ENV481 can degrade BCEE even in the absence of molecular oxygen (Fig. 3).

Monooxygenation-mediated O-dealkylation of BCEE, however, appears to be the degradation pathway used by THF- or propane-grown *Pseudonocardia* sp. strain ENV478, as demonstrated by the production of 2-chloroethanol and 2-chloroacetic acid from BCEE by this strain (Fig. 4). Strain ENV478, however, was not able to grow on BCEE as a sole carbon and energy source.

A second likely BCEE degradation pathway would involve a single dehalogenation of BCEE leading to the formation 2CEE, another growth substrate for strain ENV481. Dehalogenation of BCEE by a haloalkane dehalogenase has been reported in an *Acinetobacter* strain (6). O-dealkylation of 2CEE would likely lead the formation of ethylene glycol and 2-chloroethaldehyde; growth substrates for strain ENV481. Because we detected DEG, but not 2-chloroethanol or 2-chloroacetaldehyde in our cultures, however, this BCEE degradation pathway also is unlikely in strain ENV481.

A third potential pathway was dehalogenation followed by complete oxidation of one β -carbon prior to O-dealkylation.. *A. aquaticus* strain AD25, for example, dehalogenated 2-chlorovinylether forming 2-hydroxyvinylether (2HVE) (26). The β -hydroxy moiety of 2HVE was then completely oxidized to the carboxylic acid before scission of the vinyl ether. In the case of BCEE, an expected product would be 2-(2-chloroethoxy)acetic acid. A second dechlorination would result in the formation of 2-hydroxyethoxyacetic acid (2HEAA), a product we observed to accumulate in cultures degrading the cyclic diether 1,4-dioxane (24). An alternative mechanism would be scission of the 2-(2-chloroethoxy)acetic acid leading to 2-hydroxyacetic acid and 2-

chloroacetaldehyde. Although strain ENV481 could degrade 2-chloroacetaldehyde, we were unable to detect this product or its oxidation product 2-chloroacetic acid in BCEE-fed cultures of strain ENV481, suggesting that a different metabolic pathway was used by strain ENV481. We did observe 2HEAA in cultures of ENV481, and the strain was able to grow on this compound (Table 1), but 2HEAA was only observed after the production of DEG or when DEG was added as a sole carbon source.

Based on our analyses, the most likely pathway for BCEE degradation in strain ENV481 is sequential dehalogenation of the parent compound leading to the formation of DEG (Fig. 5). Decreases in BCEE concentrations in strain ENV481 cultures were accompanied by the sequential formation of 2CEE and DEG and the concomitant production of chloride ion at a ratio of ~2 moles of chloride per mole of BCEE degraded (Fig. 2A,B). Furthermore, the strain was able to grow on both 2CEE and DEG (Table 1). Therefore, it appears that strain ENV481 dehalogenates BCEE completely to DEG, and one β -carbon of DEG is subsequently further oxidized to form 2HEAA prior to ether scission.

Pseudomonas sp. strain AD1 performed similar sequential dehalogenation reactions with 1,3-dichloro-2-propanol via the action of a single haloalkane dehalogenase (26). Although the dehalogenase responsible for BCEE degradation in strain ENV481 has not yet been identified, it is possible that the same dehalogenase performs both dehalogenation reactions. This is supported in part by the near stoichiometric production of 2CEE from BCEE before further catabolism of the 2CEE (Fig. 2A). Several haloalkane dehalogenases studied to date have been shown to have broad substrate ranges (6, 15), and to dehalogenate chlorinated ethers (6,26) and alcohols (9). The

dehalogenation of a chlorinated alcohol ether by these enzymes, however, may be a novel reaction. The involvement of multiple dehalogenases in the same strain also cannot be completely ruled out (6, 8). The mechanism for DEG metabolism in strain ENV481 also has not yet been fully elucidated, but it did result in the production of 2HEAA that was presumably mineralized by the strain. Glycolate and glyoxylate were identified as apparent products of 2HEAA catabolism (data not shown).

Based on our analysis of BCEE degradation products and growth of strain ENV481 on potential BCEE catabolites, we propose the biodegradation pathway presented in Figure 5. The strain appears to metabolize BCEE by utilizing sequential dehalogenation reactions to produce DEG that is oxidized to 2HEAA before ether scission. The isolation of strain ENV481 from a BCEE contaminated landfill site suggests that dehalogenation may play an important role in controlling the fate of BCEE in the environment. Furthermore, the inability of strain ENV481 to grow on BTEX which comprises the bulk of the contamination at the site from which the strain was isolated suggests that BCEE may support the growth and survival of the strain ENV481 in situ. BCEE also is present in another east-coast landfill site, and BCEE degradation was observed in microcosms constructed from that site (John T. Wilson, personal communication). Experiments are planned to determine the presence of strain ENV481-like organisms in that landfill and others to better evaluate the roll of these bacteria in determining the fate of BCEE in contaminated environments.

Acknowledgements

We thank Anthony Soto, Dr. Randi Rothmel, and Paul Hedman for providing chemical analyses for this project. This work was supported in part by a grant (#CU-1422) from the Strategic Environmental Research and Development Program (SERDP) to RJS.

Literature Cited

1. **Bernhardt, D. and H. Dickmann.** 1991. Degradation of dioxane, tetrahydrofuran and other cyclic ethers by an environmental *Rhodococcus* strain. *Appl. Microbiol. Biotechnol.* **36**:120-123.
2. **Canada Environmental Protection Act.** 1993. Priority substances list assessment report: Bis(2-chloroethyl) ether. Pub. En 40-215/9E. Environment Canada, Ottawa, Ontario.
3. **Hareland, W. A., R. L. Crawford, P. J. Chapman and S. Dagley.** 1975. Metabolic function and properties of 4-hydroxyphenylacetic acid 1-hydroxylase from *Pseudomonas acidovorans*. *J. Bacteriol.* **121**:272-285.
4. **Huang, F. Y. C., K. Y. Li and C. C. Liu.** 1999. Treatability studies of groundwater contaminated with bis(2-chloroethyl) ether. *Environ. Progress* **18**:55-59.
5. **Hur, H.-G., L. M. Newman, L. P. Wackett and M. J. Sadowsky.** 1997. Toluene 2-monooxygenase-dependent growth of *Burkholderia cepacia* G4-PR1 on diethyl ether. *Appl. Environ. Microbiol.* **63**:1606-1609.
6. **Janssen, D. B., J. Gerritse, J. Brackman, C. Kalk, D. Jager and B. Witholt.** 1988. Purification and characterization of a bacterial dehalogenase with activity toward halogenated alkanes, alcohols and ethers. *Eur. J. Biochem.* **171**:67-72.
7. **Janssen, D. b., A. Scheper, L. Dijkhuizen and B. Witholt.** 1985. Degradation of halogenated aliphatic compounds by *Xanthobacter autotrophicus* GJ10. *Appl. Environ. Microbiol.* **49**:673-677.
8. **Jesenska, A., M. Pavlova, M. Strouhal, R. Chaloupkova, I. tesinska, M. monincova, Z. Prokop, M. Bartos, I. Pavlik, I. Rychlik, P. Mobius, Y. Nagata and J. Damborsky.** 2005. Cloning, biochemical properties, and distribution of *Mycobacterial* haloalkane dehalogenases. *Appl. Environ. Microbiol.* **71**:6736-6745.
9. **Kim, Y.-H. and K.-H. Engesser.** 2004. Degradation of alkyl ethers, aralkyl ethers, and dibenzyl ether by *Rhodococcus* sp. Strain DEE5151, isolated from diethyl ether-containing enrichment cultures. *Appl. Environ. Microbiol.* **70**:4398-4401.
10. **Malik, K. A. and D. Claus.** 1979. *Xanthobacter flavus*, a new species of nitrogen-fixing hydrogen bacteria. *Int. J. Syst. Bacteriol.* **29**:283-287.
11. **Moreno-Horn, M. L.-A. Garde, R. Tressl, L. Adrian and H. Gorisch.** 2003. Biodegradation of bis(1-chloro-2-propyl) ether via initial ether scission and subsequent dehalogenation by *Rhodococcus* sp. strain DTB. *Arch. Microbiol.* **179**:234-241.
12. **Quesensberry, M. S. and Y. C. Lee.** 1996. A rapid formaldehyde assay using Purpald reagent: Application under periodation conditions. *Anal. Biochem.* **234**:50-55.
13. **Rainey, F.A. and J. Wiegel.** 1996. 16S ribosomal DNA sequence analysis confirms the close relationship between the genera *Xanthobacter*, *Azorhizobium*, and *Aquabacter* and reveals a lack of phylogenetic coherence among *Xanthobacter* species. *Int. J. Syst. Bacteriol.* **46**:607-610.

14. **Rittmann, B. E. and P. L. McCarty.** 2001. Environmental Biotechnology: Principals and Applications. McGraw-Hill, New York, NY.
15. **Sato, Y., M. Monincova, R. Chaloupkova, Z. Prokop, Y. Ohtsubo, K. M. Tsuda, J. Damborsky and Y. Nagata.** 2005. Two Rhizobial Strains, *Mesorhizobium loti* MAFF303099 and *Bradyrhizobium japonicum* USDA110, encode haloalkane dehalogenases with novel structures and substrate specificities. Appl. Environ. Microbiol. **71**:4372-4379.
16. **Smith, C. A., K. T. O'Reilly and M. R. Hyman.** 2003. Characterization of the initial reactions during the cometabolic oxidation of methyl tert-butyl ether by propane-grown *Mycobacterium vaccae* JOB5. Appl. Environ. Microbiol. **69**:796-804.
17. **Smith, L. H., P. L. McCarty and P. K. Kitanidis.** 1998. Spreadsheet method for evaluation of biochemical reaction rate coefficients and their uncertainties by weighted nonlinear least-squares analysis of the integrated Monod parameters. Appl. Environ. Microbiol. **64**:2044-2050.
18. **Steffan, R. J., Y. Farhan, C. W. Condee and S. Drew.** 2003. Bioremediation at a New Jersey site using propane-oxidizing bacteria. p. 506-516. In E. E. Moyer and P. T. Kosteki (ed), MTBE Remediation Handbook, Amherst Scientific Publishers, Amherst, MA.
19. **Steffan, R. J., K. McClay, S. Vainberg, C. W. Condee and D. Zhang.** 1997. Biodegradation of the gasoline oxygenates methyl tert-butyl ether, ethyl tert-butyl ether, and tert-amyl methyl ether by propane-oxidizing bacteria. Appl. Environ. Microbiol. **63**:4216-4222.
20. **Thierner, B., J. R. Andreasen and T. Schrader.** 2003. Cloning and characterization of a gene cluster involved in tetrahydrofuran degradation in *Pseudonocardia* sp. Strain K1. Arch. Microbiol.:266-277.
21. **U.S. Environmental Protection Agency.** 1987. Health Effects Assessment for Bis(2-chloroethyl)ether. Pub. no. EPA/600/8-88/023
22. **U.S. Environmental Protection Agency.** 2007. Human health risk assessment. <http://www.epa.gov/reg3hwmd/risk/human/index.htm>
23. **U.S. Environmental Protection Agency.** 1996. Soil Screening Guidance: User's Guide, Second Edition. Office of Solid Waste and Emergency Response pub. no. 9355.4-23.
24. **Vainberg, S., K. McClay, H. Masuda, D. Root, C. W. Condee, G. J. Zylstra and R. J. Steffan.** 2006. Biodegradation of ether pollutants by *Pseudonocardia* sp. strain ENV478. Appl. Environ. Microbiol. **72**:5218-5224.
25. **Vainberg, S., A. P. Togna, P. M. Sutton and R. J. Steffan.** 2002. Treatment of MTBE-contaminated water in fluidized bed bioreactor (FBR). J. Environ. Engineer. **128**:842-851.
26. **van den Wijngaard, A., J. Prins, A. J. A. C. Smal and D. B. Janssen.** 1993. Degradation of 2-chloroethylvinylether by *Ancylobacter aquaticus* AD25 and AD27. Appl. Environ. Microbiol. **59**:2777-2783.
27. **van den Wijngaard, A. J., R. D. Wind and D. B. Janssen.** 1993. Kinetics of Bacterial Growth on Chlorinated Aliphatic Compounds. Appl. Environ. Microbiol. **59**:2041-2048.

28. **White, G. F., N. J. Russell and E. C. Tidswell.** 1996. Bacterial scission of ether bonds. *Microbiol. Rev.* **60**:216-232.
29. **World Health Organization.** 1998. Selected chloroalkyl ethers, Environmental Health Criteria, No 201. WHO Press. ISBN 9789241572019

Figure 1. Growth of ENV481 on BCEE (closed circles) or 2-chloroethyl ethyl ether (closed squares). Symbols represent means (n=3), and error bars represent one standard error.

Figure 2. Biodegradation of BCEE (A) and 2CEE (B) by strain ENV481. The assays presented in panel A contained 0.18 g dwt/L ($OD_{550} = 0.65$) of strain ENV481, and those presented in panel B contained 0.46 g dwt/L ($OD_{550} = 1.65$) of strain ENV481. Symbols represent BCEE (closed squares), 2-(2-chloroethoxy)-ethanol (2CEE) (closed circles), DEG (open squares) and chloride (open circle). Symbols represent means (n=3), and error bars represent one standard error.

Figure 3. Biodegradation of BCEE by strain ENV481 under anaerobic conditions. Symbols represent BCEE (closed circles), 2CEE (Closed squares), and chloride (closed triangles). Values represent means (n=3), and error bars represent one standard error of the mean. The first sample was collected after 10 min. of incubation.

Figure 4. Biodegradation of BCEE by strain ENV478. Symbols represent BCEE (closed circles) and 2-chloroacetic acid (closed squares). Values represent means (n=3), and error bars representing one standard error are within the size of the symbols.

Figure 5. Proposed BCEE biodegradation pathways in strains ENV481 (left) and ENV78 (right). Compounds shown in brackets were not analyzed in this study, but are expected based on the other products detected.

Growth substrate	Growth rate constant (h ⁻¹)	Doubling time (h)	Yield (g dwt L ⁻¹ g substrate ⁻¹)	Maximum Utilization Rate (mmol/g dwt/hr)	Half Velocity (mmol/L)
BCEE	0.040	16	0.18	2.2 ± 0.4	0.14 ± 0.09
2-(2-chloroethoxy)-ethanol (2CEE)	0.040	17	0.20	0.38 ± 0.1	0.31 ± 0.3
2-chloroethyl ethyl ether	0.019	36	0.24	ND	ND
DEG	0.045	16	0.29	ND	ND
HEAA	0.017	41	0.23	ND	ND
2-chloroacetic acid	0.012	60	0.08	ND	ND
2-chloroethanol	0.027	25	0.25	ND	ND
Ethylene glycol	0.061	11	0.26	ND	ND

Table 1. Strain ENV481 Growth and Biodegradation Kinetics.

N.D. not determined

± values represent 95% confidence intervals

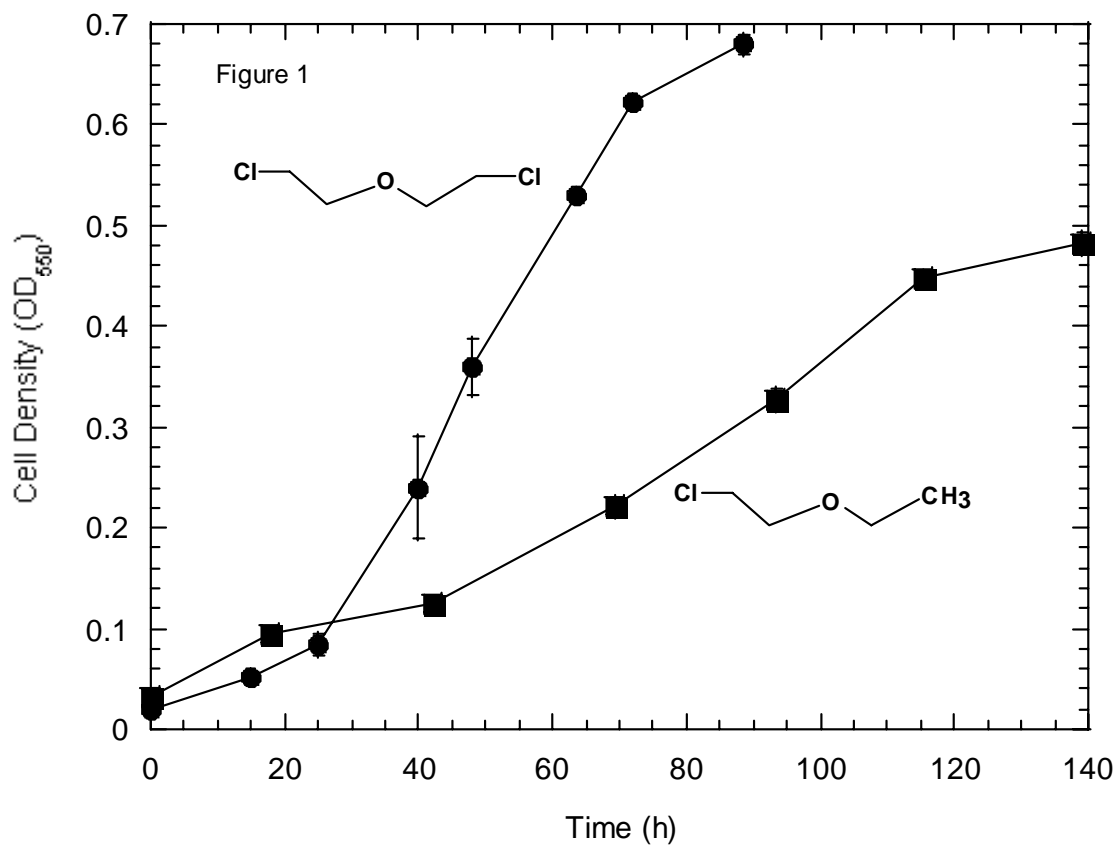

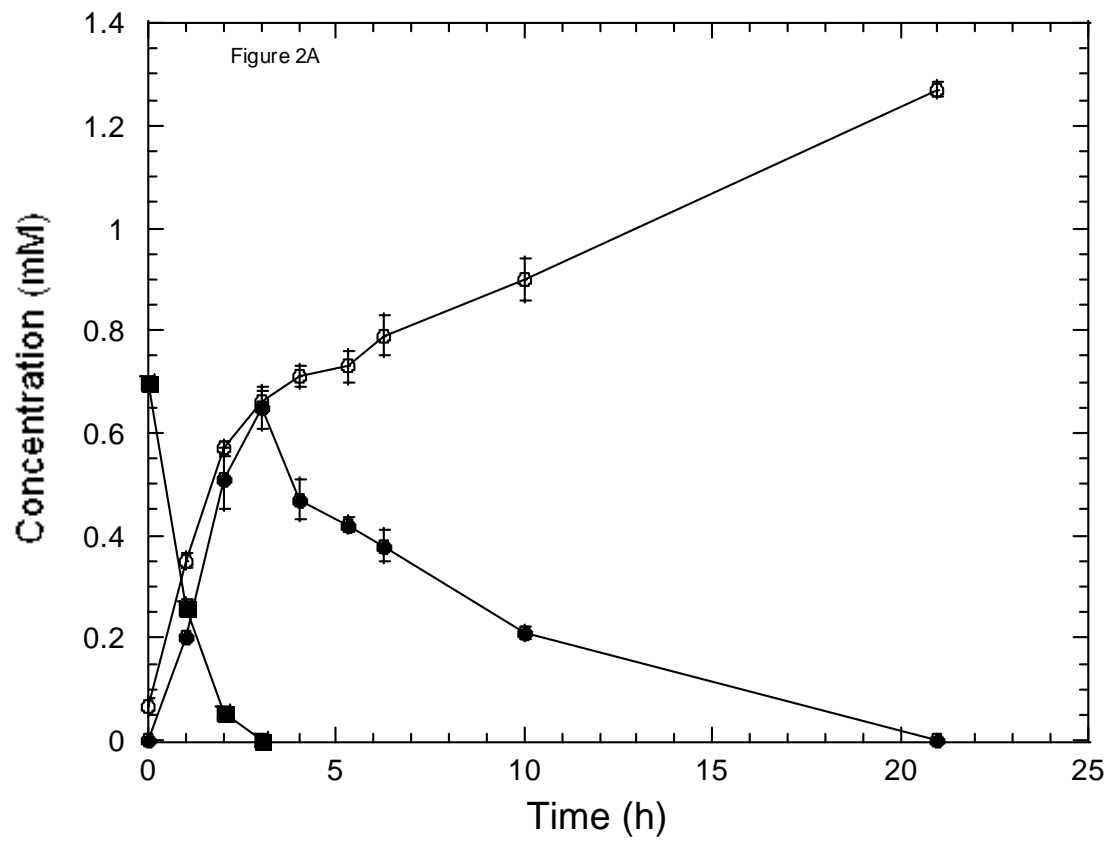

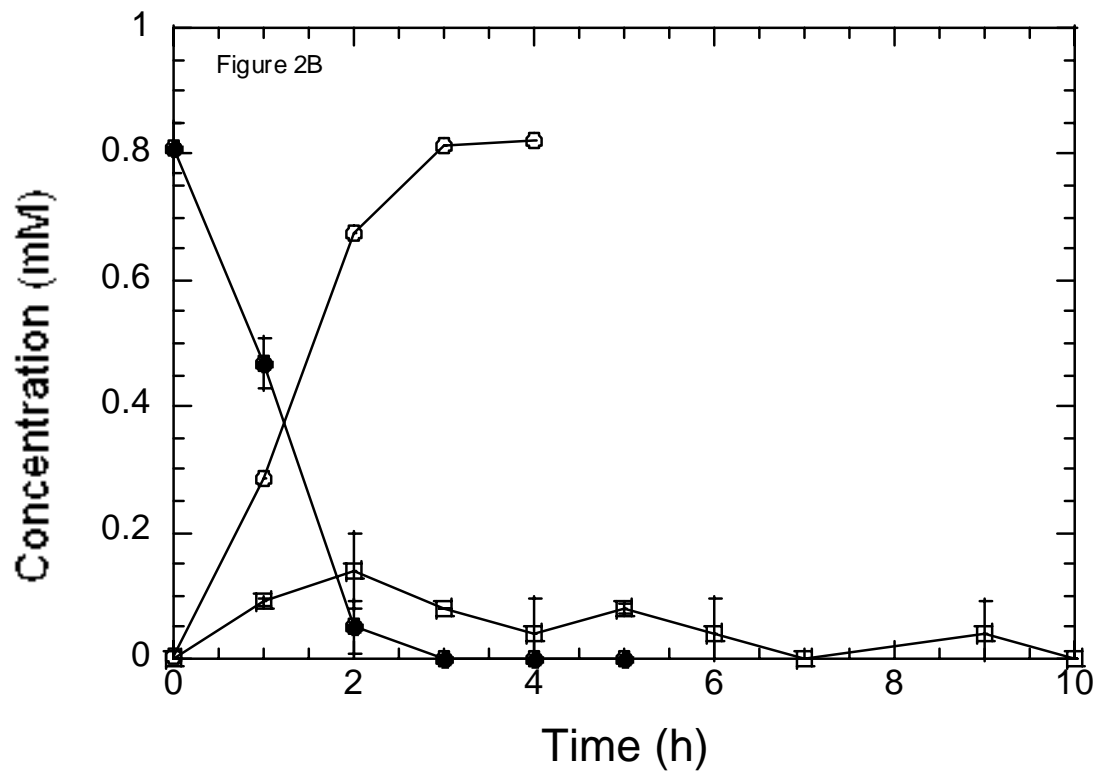

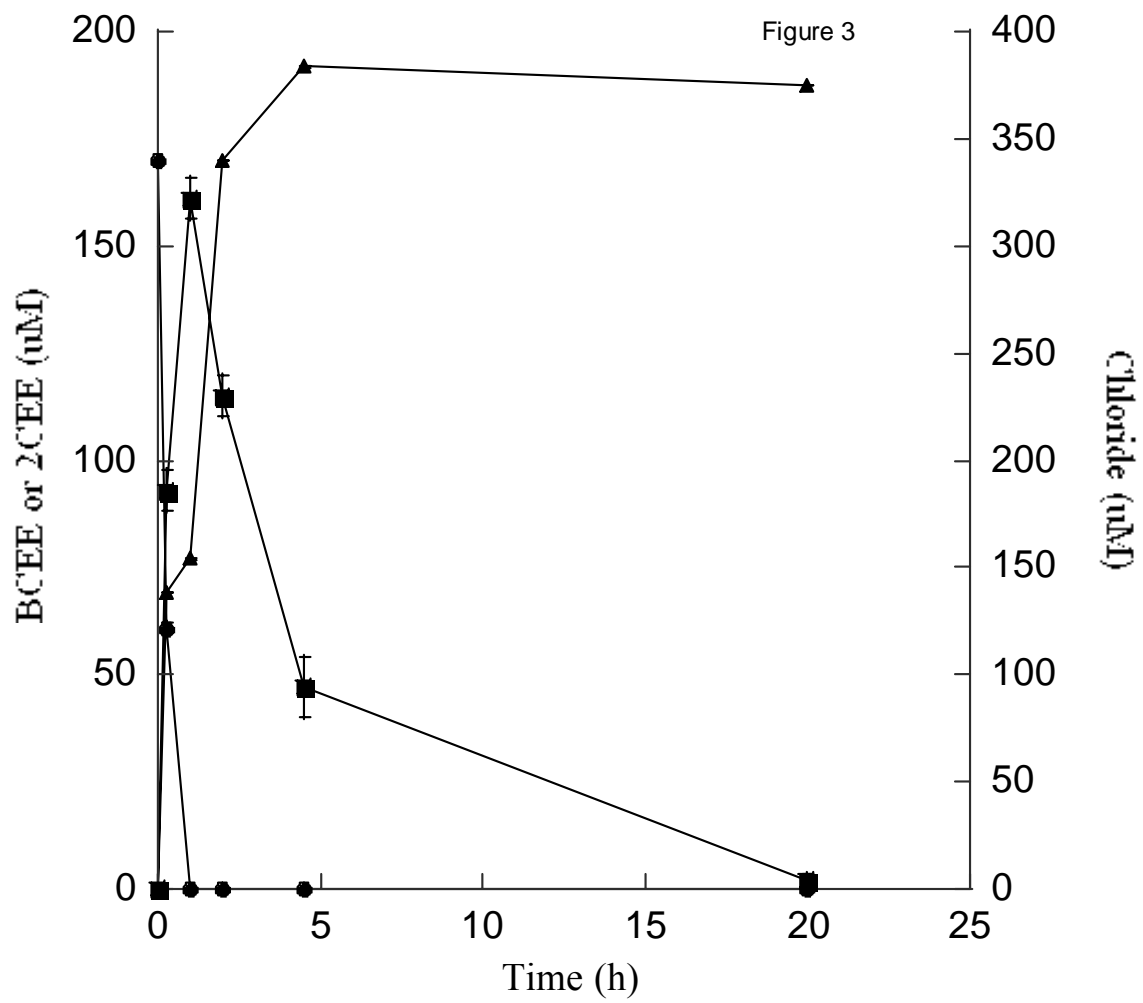

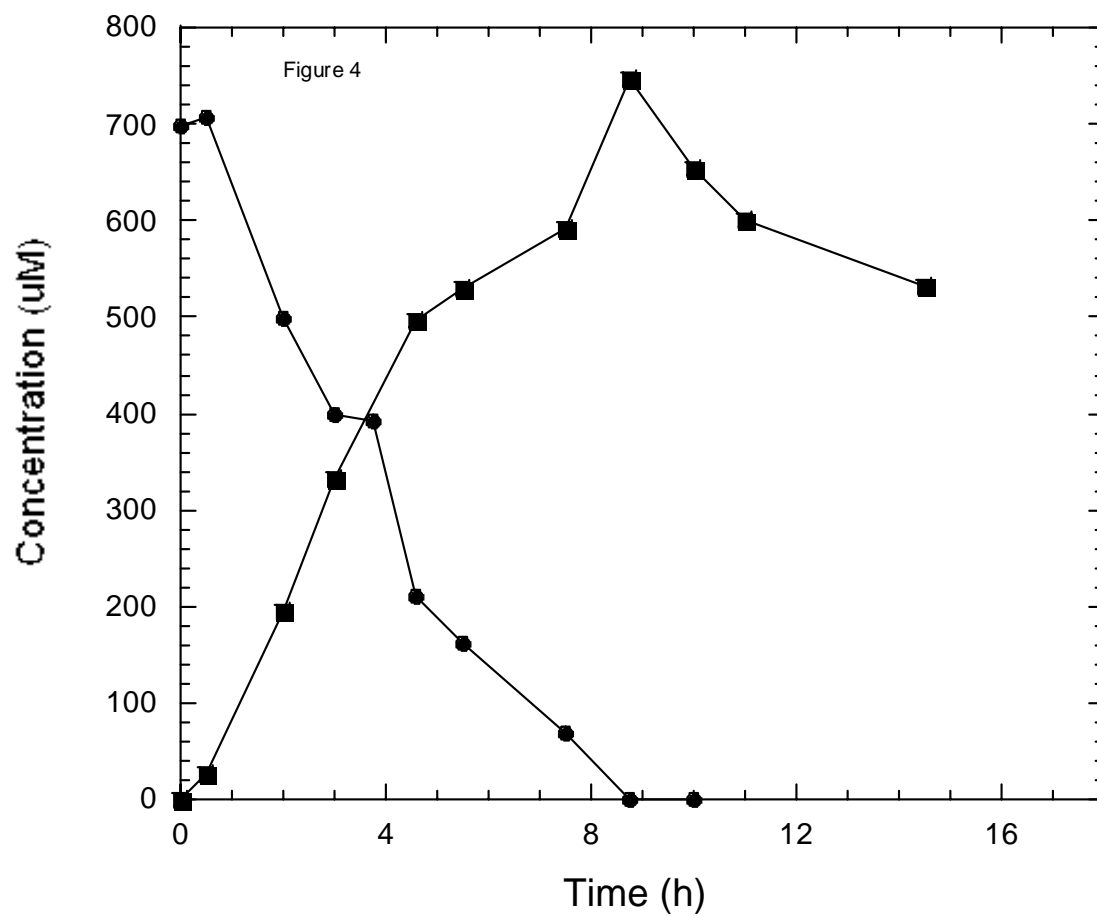

Figure 5

